

**EPSON® PowerLite® 7700p
Multimedia Projector**

User's Guide

Important Safety Information

WARNING: Never look into the projector lens when the lamp is turned on; the bright light can damage your eyes. Never let children look into the lens when it is on. Never open any cover on the projector, except the lamp and filter covers. Dangerous electrical voltages inside the projector can severely injure you. Except as specifically explained in this *User's Guide*, do not attempt to service this product yourself. Refer all servicing to qualified service personnel.

WARNING: The projector and its accessories come packaged in plastic bags. Keep plastic bags away from small children to avoid any risk of suffocation.

Caution: When you replace the lamp, never touch the new lamp with your bare hands; the invisible residue left by the oil on your hands may shorten the lamp life. Use a cloth or glove to handle the new lamp.

Copyright Notice

All rights reserved. No part of this publication may be reproduced, stored in a retrieval system, or transmitted in any form or by any means, electronic, mechanical, photocopying, recording, or otherwise, without the prior written permission of SEIKO EPSON CORPORATION. The information contained herein is designed only for use with this EPSON product. EPSON is not responsible for any use of this information as applied to other products.

Neither SEIKO EPSON CORPORATION nor its affiliates shall be liable to the purchaser of this product or third parties for damages, losses, costs, or expenses incurred by purchaser or third parties as a result of: accident, misuse, or abuse of this product or unauthorized modifications, repairs, or alterations to this product, or (excluding the U.S.) failure to strictly comply with SEIKO EPSON CORPORATION's operating and maintenance instructions.

SEIKO EPSON CORPORATION shall not be liable for any damages or problems arising from the use of any options or any consumable products other than those designated as Original EPSON Products or EPSON Approved Products by SEIKO EPSON CORPORATION.

EPSON is a registered trademark of SEIKO EPSON CORPORATION.

EPSON PrivateLine and Extra Care are service marks; EPSON Store and SizeWise are trademarks; and Presenters Club and PowerLite are registered trademarks of Epson America, Inc.

General Notice: Other product names used herein are for identification purposes only and may be trademarks of their respective owners. EPSON disclaims any and all rights in those marks.

C

Contents

Welcome

Getting the Most from Your Projector	2
Using Your Documentation	3
Reading This Manual Online	3
Getting More Information	4
Registration and Warranty	5
Unpacking the Projector	6
Additional Components	7
Optional Accessories	8

1 *Setting Up the Projector*

Positioning the Projector	10
Connecting to a Laptop Computer	12
Connecting the Computer Cable	12
Connecting the Cable for Remote Mouse Control	13
Amplifying Computer Audio	14
Connecting to Video Sources	15
Connecting RCA Video Cables	16
Connecting S-Video	17
Connecting Component Video Cables	18

2 *Using the Projector*

Turning On Your Equipment	20
Turning On the Projector	20
What To Do If You See a Blank Screen	22

Adjusting the Image	24
Focusing and Zooming Your Image	24
Resizing the Image	25
Adjusting the Height of Your Image	25
Adjusting the Image Shape	26
Adjusting the Tracking and Synchronization	26
Controlling the Projector	27
Switching Between Picture Sources	27
Adjusting the Volume	27
Turning Off the Picture and Sound	27
Shutting Down the Projector	28

3 *Using the Remote Control*

Turning On and Using the Remote Control	30
Installing Batteries	30
Turning On the Remote Control	30
Using the Remote Control	31
Controlling the Picture and Sound	32
Switching Between Picture Sources	32
Adjusting the Volume	32
Turning Off the Picture and Sound	33
Stopping Action	33
Zooming Your Image	33
Displaying Picture-in-Picture Video	34
Highlighting Your Presentation	35
Using the Pointer	35
Using Box Highlights	36
Spotlighting Your Image	36
Using Horizontal and Vertical Highlights	37
Using the Remote Control as a Wireless Mouse	38

4 *Fine-tuning the Projector*

Using the Projector's Menu System	40
Changing Menu Settings	41
Adjusting the Image	43
Repositioning the Image	44
Adjusting Image Appearance	44
Saving and Recalling Computer Settings	45

Adjusting the Sound	46
Customizing the Highlighting Tools	47
Creating Your Own Startup Screen	49
Capturing the Image	49
Setting Up When the Image Displays	50
Customizing Projector Features	51
Setting Advanced Features	53
Viewing Lamp Usage and Other Information	54
Restoring the Default Settings	55

5 *Maintaining and Transporting the Projector*

Cleaning the Lens	58
Cleaning the Projector Case	58
Cleaning and Replacing the Air Filter	59
Replacing the Lamp	60
Resetting the Lamp Timer	62
Transporting the Projector	63

6 *Solving Problems*

Using On-Screen Help	66
What To Do When the Lights Flash	67
Solving Problems with the Image or Sound	69
Solving Problems with the Remote Control	74
Where To Get Help	75
Telephone Support Services	75

Appendix A: Connecting to Additional Equipment

Installing the Projector	78
Controlling the Projector from a Computer	78
Connecting to an External Audio System	79
Connecting to a PC Desktop Computer	80
Connecting the Computer and Monitor Cables	80
Connecting the Mouse Cable	81
Connecting the Audio Cable	82
Connecting to a Desktop Macintosh	83
Connecting the Computer and Monitor Cables	83
Connecting the Mouse Cable	85
Connecting the Audio Cable	86

Connecting to a Second Computer	87
Connecting to a High-End Workstation	88
Connecting to a DVI Video Source	89

*Appendix B:
Notices*

Important Safety Instructions	91
Remote Control Information	93
Declaration of Conformity	94
FCC Compliance Statement	95

*Appendix C:
Technical
Specifications*

General	97
Projection Lamp	98
Remote Control	98
Mouse Compatibility	98
Remote IR Receiver	98
Dimensions	98
Electrical	98
Environmental	99
Safety	99
Compatible Video Formats	99
Interface Connectors	102
Computer Video Port Pin Assignments	103
Image Size and Projection Distance	104

Index

W *Welcome*

The EPSON® PowerLite® 7700p is a portable projector offering 3000 ANSI lumens of brightness. From boardrooms to auditoriums, your full-color presentations and videos will be bright and visible even in ordinary room lighting.

Images are displayed at a resolution of 1024 × 768 pixels. The new 1.3-inch LCD provides a 400:1 contrast ratio for incredibly vivid images and clear text. Improved video processing reduces “color noise” for rich, saturated images. Reduced light leakage and whisper-quiet operation contribute to theater-quality video.

With EPSON’s patented SizeWise™ chip, the projector supports computer displays ranging from VGA through UXGA, as well as the Digital Visual Interface (DVI) format.

You can connect the projector to a wide range of computers, including IBM® compatible PCs and laptops, Apple® Macintosh®, Power Macintosh™ series (including G3 and G4 systems), PowerBook® computers, many iMac™ and iBook™ series systems, and high-end workstations such as the Sun® SPARCstation™.

You can use any of the following video sources: VCR, DVD player, camcorder, digital camera, or laser disc player, supporting HDTV, NTSC, PAL, or SECAM video. The projector automatically senses the video format, which can be composite video, S-Video, or component video.

Getting the Most from Your Projector

note

You can connect a maximum of four sources at the same time.

Your EPSON PowerLite 7700p is a highly versatile presentation tool. You can connect it to one or two computer sources and up to three video sources and easily switch between them. You can also include sound for up to three of the sources.

Depending on your presentation, you can take advantage of any or all of these options:

- **Connecting to a laptop or other computer**

If you want to connect to a PC laptop or Macintosh PowerBook, see page 12. To connect to a desktop computer, a workstation, a computer that outputs video in Digital Visual Interface (DVI) format, or more than one computer, see Appendix A.

- **Connecting to video sources**

You can connect a DVD player, VCR, camcorder, laser disc player, digital camera, or any other video source to your projector. You can connect several types of video sources at the same time (with or without a computer) and easily switch between them. See page 15 for instructions.

- **Using the remote control**

The remote control lets you switch from one computer or video source to another, with access to picture-in-picture, pointer, zoom, and many other projector features. For details, see “Using the Remote Control” on page 29.

By connecting an additional cable, you can also use the remote control as a wireless mouse. This lets you click through slideshow-style presentations (such as PowerPoint®) from up to 30 feet away. For more information, see page 38.

- **Including sound in your presentation**

If your presentation includes sound, you can connect an audio cable to use the projector’s built-in stereo speakers. For details, see page 14 (for laptops) or Appendix A (for other systems).

If you’re permanently installing the projector, you may wish to connect external speakers or a public address system to the projector’s **Audio Out** port; see page 79.

■ Controlling Your Projector from a Computer

If you want to be able to control the projector's settings from your computer (for example, if the projector is ceiling-mounted), you can install the EMP Link V program on the Projector Software CD-ROM. In addition to making the projector's features accessible from your computer, this program lets you customize the highlighting tools (special effects buttons on the remote control). For details, see page 78.

note

The EMP Link program is optional; you do not need to install it to use the projector.

Using Your Documentation

To connect the projector to your laptop and get your presentation running fast, see the *Quick Setup* sheet that came in your *Owner's Kit*.

This book contains all the information you need to set up and use your projector. Please follow these guidelines as you read through it:

- Warnings must be followed carefully to avoid bodily injury.
- Cautions must be observed to avoid damage to your equipment.
- Notes contain important information about your projector.

Reading This Manual Online

Your PowerLite 7700p CD-ROM includes an electronic copy of this manual. You may find it convenient to copy it onto your laptop's hard drive so it's always with you—for example, when taking your presentation on the road.

To view your electronic manual, you need to use Adobe® Acrobat® Reader. Just insert the PowerLite 7700p CD-ROM in your CD-ROM drive, select the **Install/View User's Guide** button and click **Install User's Guide** or **View User's Guide**.

note

If you do not have Acrobat Reader, you can install it from the CD-ROM.

When you open the manual, you see this toolbar:

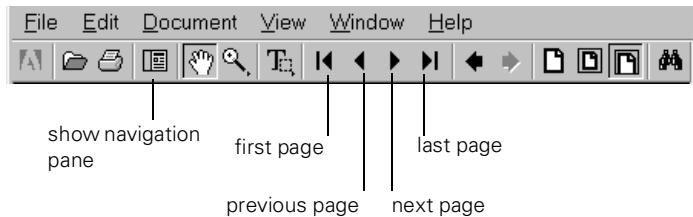

You have several ways to navigate through the manual:

- Click in the table of contents on the left side of the screen to move quickly to the topic of your choice.
- Use the arrow buttons in the toolbar or on the vertical scroll bar on the right side of the screen to move through the manual.
- If you hold your mouse pointer over text and the hand changes to an index finger, you can click to jump to a related topic.

For more information, see your Acrobat Reader online guide.

Getting More Information

Need tips on giving presentations? Quick steps for setting up your projector? Here's where you can look for help:

- **www.presentersonline.com**
Includes a library of articles covering presentation tips, tricks, and technology. The site provides templates, clip art and sound clips, as well as Presenters Services to use on the road. Even more resources and services are available if you register to join the Presenters Club®—and it's free.
- ***Quick Setup* sheet**
Gives you all the instructions you need to get your projector set up and connected to a laptop or PowerBook computer.
- ***Owner's Kit* folder**
Includes your *Quick Setup* sheet, warranty brochures, CD-ROMs, and EPSON PrivateLineSM Support card. Store this *User's Guide* in the folder and keep the folder with your projector at all times.

- **Built-in help system**
Provides assistance for common problems. Available from the Help button on the projector or the remote control. See page 66 for details.
- **support.epson.com**
Download FAQs and e-mail your questions to EPSON support.
- **CD-ROMs**
Your *Owner's Kit* includes two CD-ROMs. The PowerLite 7700p CD-ROM lets you register electronically and includes the electronic copy of this book as well as a link to *Presenters Online*. On the Projector Software CD-ROM, you'll find the optional EMP Link V program and its *User's Guide*.

If you still need help after checking this *User's Guide* and the sources listed above, you can use the EPSON PrivateLine Support service to get help fast. Call (800) 637-7661 and enter the PIN on the card in your *Owner's Kit*. Or take advantage of EPSON's automated support services 24 hours a day. See page 75 for more information.

note

You don't need to install any software to use your projector.

Registration and Warranty

Your projector comes with a basic carry-in warranty as well as an international warranty that let you project with confidence anywhere in the world. For details, see the warranty brochures included in your *Owner's Kit*.

In addition, for customers who register their projector, EPSON offers free Extra CareSM Road Service. In the unlikely event of an equipment failure, you won't have to wait for your unit to be repaired. Instead, EPSON will ship you a replacement unit anywhere in the United States or Canada via overnight delivery. See the brochure in your *Owner's Kit* for details.

To register, simply insert the PowerLite 7700p CD-ROM that came with your projector and select **Register Online**. Registering also lets you receive special updates on new accessories, products, and services. You can register through the Internet, by e-mail or 800-number modem connection, or by printing out the form to fax or mail.

Unpacking the Projector

After unpacking the projector, make sure you have all the parts shown below:

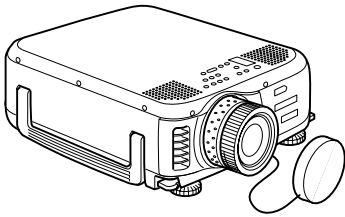

projector



remote control



EPSON PowerLite 7700p CD-ROM
(not needed to use your projector)



batteries

Projector Software
CD-ROM (optional)

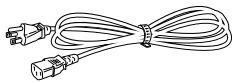

power cord



computer cable

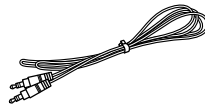

computer audio cable



RCA audio cable



RCA video cable

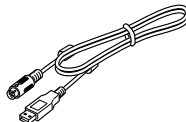

USB mouse cable

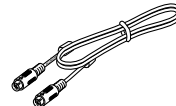

PS/2[®] mouse cable

Save all packaging in case you need to ship the projector. Always use the original packaging (or the equivalent) when you need to send the projector to another location.

If you are moving the projector by hand, use a carrying case (such as the optional cases available from EPSON). See page 8 for more information about cases.

Additional Components

Depending on how you plan to use the projector, you may need additional components:

- To receive an S-Video signal, you need an S-Video cable. (One is usually provided with your video device.)
- To receive a component video signal from a VCR or other video device, you need a BNC cable (usually provided with the device).
- To connect two computers to the projector at the same time, you need a VGA to BNC cable. To amplify the second computer's audio through the projector's sound system, you need an RCA-to-3.5 mm stereo cable. See your computer or electronics dealer to obtain these cables.
- Some older PowerBooks and Macintosh desktop models may need the Macintosh adapter set shown on page 83 (available from EPSON; see page 8). Older iMac systems may need a special adapter to provide a VGA output port; see your computer dealer.
- Some systems may need an additional cable to use the remote control as a wireless mouse. If your Macintosh doesn't have a USB port, you'll need a Macintosh mouse cable. If your PC doesn't have a USB or PS/2 port, you'll need a PC serial cable. See your projector dealer to obtain the correct cable.
- If you plan to use the EMP Link V software to control the projector, you'll need a standard serial cable, which you may purchase from your computer dealer.
- To take advantage of the projector's Digital Visual Interface, you need a DVI cable, and your computer must be capable of producing video signals in DVI format (for details, see page 89). You can purchase this cable from EPSON; see page 8.

Optional Accessories

To enhance your use of the projector, EPSON provides the following optional accessories:

Product	Product number
Replacement lamp and air filter	ELPLP12
Long throw zoom lens	ELPAL01
Wide angle lens	ELPAW01
Customized carrying cases: Samsonite® wheeled soft case ATA molded hard shell case ATA shipping case	ELPKS35 ELPKS38 ELPKS39
Ceiling mount	ELPM334
Suspension adapter for ceiling mount	ELPMBAST
Kensington security lock	ELPSL01
Portable projection screens: 60-inch 80-inch	ELPSC07 ELPSC08
Wireless microphone and two satellite speakers	ELPCUS1
Auxiliary audio system	ELPPAS1
Remote control receiver (plugs into projector to extend range of remote control)	ELPST02
Remote control receiver kit (includes standard receiver and clip-on receiver for attachment directly to remote control)	ELPST04
Macintosh adapter set (includes monitor adapter and desktop adapter)	ELPAP01
VGA to 13W3 video cable (for connecting to certain high-end workstations)	ELPKC06
Digital video cables: DVI to DVI, 10 feet (3 meters) DVI to DFP, 10 feet (3 meters)	ELPKC20 ELPKC21

You can purchase these accessories from your dealer or by calling EPSON at (800) 873-7766; or visit the EPSON Store™ at www.epson.com (U.S. sales only). In Canada, please call (800) 873-7766 for dealer referral.

1 *Setting Up the Projector*

This chapter tells you how to set up the projector for a laptop computer or video presentation. If you need to set up the projector for a permanent installation or connect it to a desktop or workstation computer, see Appendix A.

You'll find instructions for the following in this chapter:

- Positioning the projector
- Connecting to a laptop computer
- Connecting to video sources

Positioning the Projector

Before connecting the projector, you need to decide where to place it. The location you choose depends on the size of the room and what you are projecting.

caution

Don't hold or lift the projector by the lens, or you may damage it.

note

It's easier to position the projector when the screen is directly in front of the room. If the screen is placed diagonally in a corner, it's much more difficult to aim the projector correctly at the screen and get a square image.

- Place the projector on a sturdy, level surface, between 3.6 and 47.6 feet from the screen.
- Make sure there is plenty of space for ventilation around and under the projector.
- Make sure the projector is within 10 feet of a grounded electrical outlet or extension cord, and within 5 feet of your computer and/or video source.
- Place the projector directly in front of the center of the screen, facing it toward the screen squarely. Otherwise, your image will not be square.

Most presenters find it convenient to place the projector in front of the audience, leaving as much space as possible between the projector and the screen to get a good-sized image. This lets the presenter stand in the front of the room, face the audience, and remain close enough to the equipment to be able to control it.

Use the figure below as a guideline to help you determine how far from the screen to place the projector. Image size generally increases with distance, but may vary depending on how you position the zoom ring and whether you have adjusted the image size with other settings. The dimensions shown are based on using the standard lens.

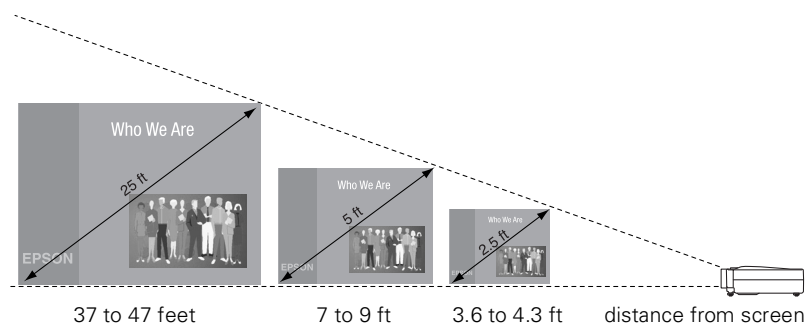

If you place the projector below the level of the screen, you'll have to tilt it up by extending the feet as shown. Tilting the projector upward causes the image to lose its square shape, but you can correct the distortion by pressing the **Keystone** button as described in the next chapter.

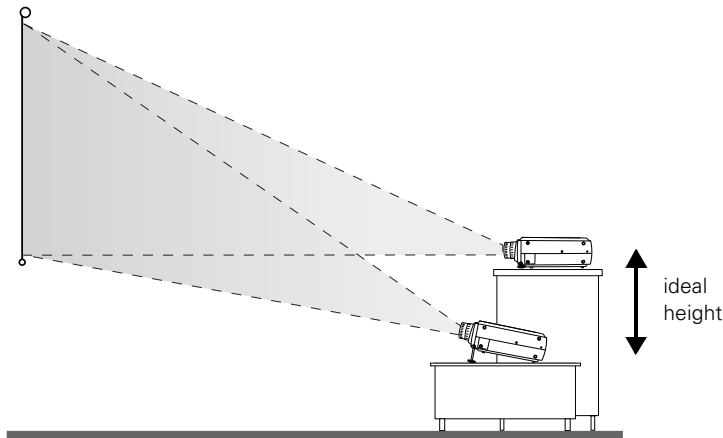

If you place the projector level with the bottom of the screen, the image will be square and you won't have to adjust it. If you place the projector higher than the bottom of the screen, the image will still be square, but you won't be able to fill the whole screen with the image.

note

After positioning the projector, you may want to connect a Kensington MicroSaver® anti-theft device to the lock port on the projector's left side. You can purchase this from EPSON; see "Optional Accessories" on page 8.

Connecting to a Laptop Computer

note

To connect to desktops and other computer systems, see Appendix A. If you have an iBook with an RCA video-out port, follow the instructions for connecting to a video device on page 16.

You can connect the PowerLite projector to any computer that has a standard video output (monitor) port, including PC notebook and laptop computers, Macintosh PowerBooks, and hand-held devices.

Connecting the Computer Cable

Before you start, make sure your computer and the projector are turned off.

1. Connect one end of the computer cable to the projector's Computer 1 port.

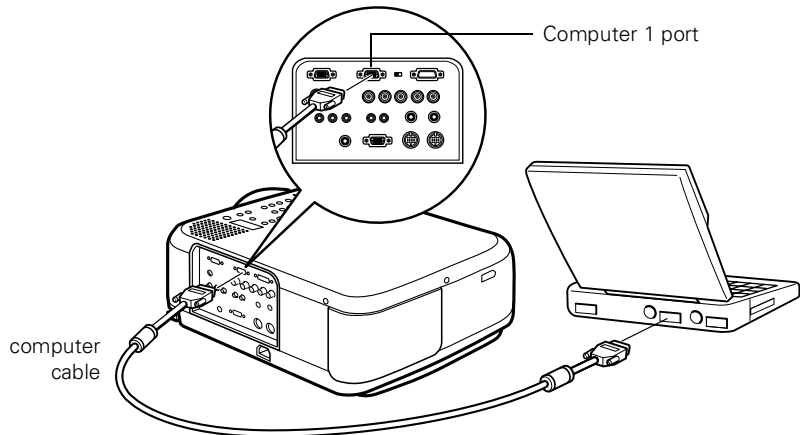

2. Make sure the Computer 1 switch is flipped to the left (to the Analog position, as shown). If necessary, use the tip of a ballpoint pen to slide it over.
3. Connect the other end of the computer cable to your laptop's video-out or monitor port.

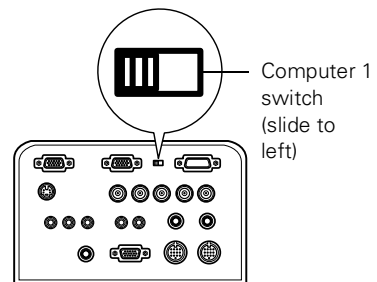

note

Laptop configurations vary. See your computer manual for the location of the ports needed to connect your projector.

If you're using a PowerBook and you can't connect the cable, you may need to use the Macintosh desktop adapter as shown on page 83 (available from EPSON; see page 8).

4. Tighten the screws on the connectors.

If you don't need to make any other connections, you can plug in your projector and turn it on. See page 20 for instructions.

Connecting the Cable for Remote Mouse Control

Using the remote control as a wireless mouse lets you click through slideshow-style presentations, such as PowerPoint, from up to 30 feet away (for details, see page 38). This gives you more flexibility in delivering your presentation, since you won't need to stand near your computer.

1. Locate the cable you need, depending on whether your laptop has a round PS/2 mouse port or a flat USB mouse port.
2. Connect the round end of the cable to the projector's **Mouse1** port, as shown.

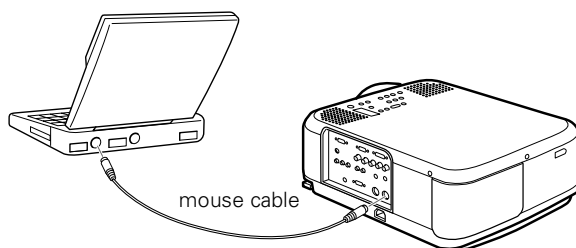

3. Connect the other end of the cable to the external mouse port or USB port on your laptop.
4. If necessary, configure your laptop to work with an external mouse.

If you don't need to make any other connections, you can plug in your projector and turn it on. See page 20 for instructions.

note



If you're using a PowerBook that has a round mouse port, you'll need a Macintosh mouse cable. See your projector dealer to obtain the correct cable.

Amplifying Computer Audio

Your laptop probably has its own sound system; however, it may not be adequate for your presentation. If you need more volume or better sound quality, you can connect the audio cable to take advantage of the projector's built-in amplifier and stereo speakers.

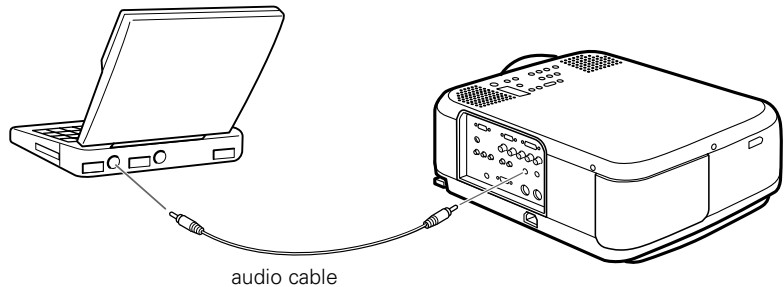
1. Connect one end of the audio cable to the **Audio (Computer1)** jack on the projector.



2. Connect the other end of the audio cable to your laptop's  headphone jack or  audio-out jack. (Jack locations vary; see your computer manual if you're not sure of which jack to use.)

If you don't need to make any other connections, you can plug in your projector and turn it on. See page 20 for instructions.

Connecting to Video Sources

You can connect a DVD player, VCR, camcorder, laser disc player, digital camera, or any other compatible video source to your projector.

The projector supports HDTV, NTSC, PAL, and SECAM, and automatically detects the video format. (However, if you're using a 60-hertz PAL system, you'll need to select PAL60 in the Video menu, as described on page 45.)

The projector can receive composite video, S-Video, and component video. You can connect the projector to one or more of these video sources at the same time. If all three are connected, the projector automatically selects S-Video as the video source.

The type of cable you use depends on whether you have composite video, S-Video, or component video.

- For composite video, use the RCA video cables included with the projector.
- For component video, use the BNC-style cable that came with your video device.
- For S-Video, use the S-Video cable supplied with your video device or obtain one from your electronics dealer.

See the following illustration if you're unsure of which type of connectors you have.

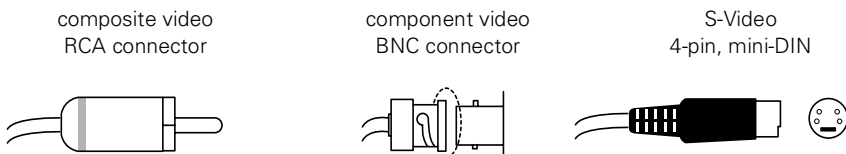

Follow the instructions below for your type of connection.

note

The projector does not support TV antenna cable F connectors.

Connecting RCA Video Cables

Before starting, make sure the projector and your DVD player or other video source are turned off.

1. Connect the yellow plug on one end of the RCA video cable to the projector's Video jack.
2. Connect the other end of the cable to the video-out jack on your video source.

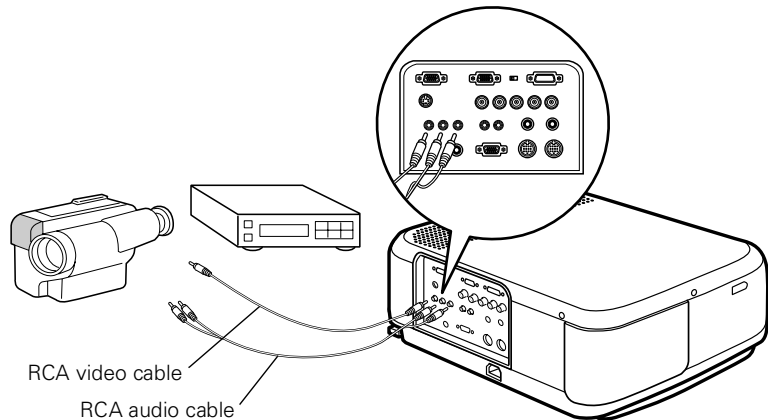

3. Connect the RCA audio cable to the left and right Audio jacks on the projector (insert the white plug into the L port and the red plug into the R port).
4. Connect the plugs at the other end of the cable to the audio output jacks on your video source.

Connecting S-Video

If your video source has an S-Video jack, you can use it to project a higher quality video image. However, you'll need an S-Video cable, which may be included with your video source, or may be purchased.

Before starting, make sure the projector and your DVD player or other video source are turned off.

1. Insert one end of an S-Video cable into the projector's S-Video connector.
2. Insert the other end into the S-Video output port of your video source.

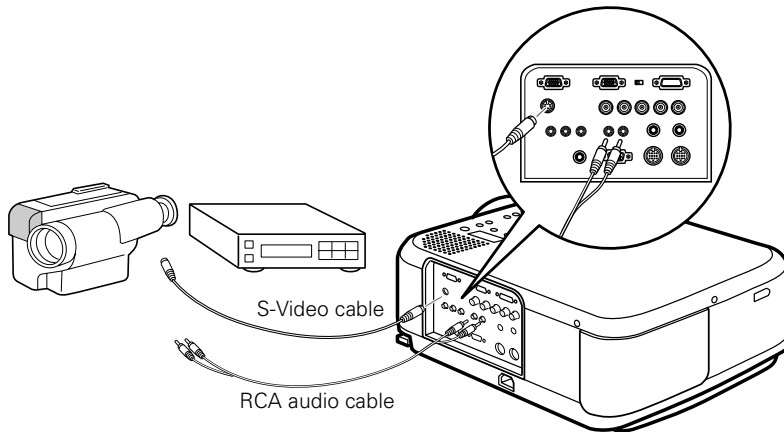

3. Connect the RCA audio cable to the left and right S-Video/BNC audio jacks on the projector. (Match the red and white plugs to the red and white jacks.)
4. Connect the plugs at the other end of the cable to the audio output jacks on your video source.

note

The Computer2/Component Video port and the S-Video port share the same audio input. If you've connected a video source to both interfaces, you can use audio from only one of the sources.

Connecting Component Video Cables

If your video source has component video connectors, you can use them to project a higher quality video image. However, you'll need a BNC video cable, which may be included with your video source, or may be purchased.

Before starting, make sure the projector and your DVD player or other video device are turned off.

1. Connect the three ends of the component video cable into the projector's R, G, and B ports. (Don't connect the cables to the projector's H/C Sync or VSync ports.)
2. Insert the opposite ends of the cable into the corresponding ports on your video source. If the image doesn't display properly, you may need to change the BNC option in the projector's Setting menu (see page 52).

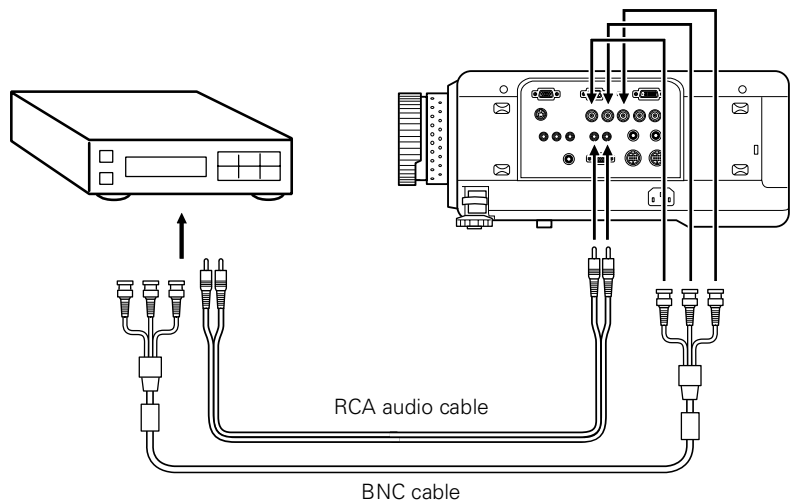

note

The Computer2/Component Video port and the S-Video port share the same audio input. If you've connected a video source to both interfaces, you can use audio from only one of the sources.

3. Connect the RCA audio cable to the left and right S-Video/BNC audio jacks on the projector. (Match the red and white plugs to the red and white jacks.)
4. Connect the plugs at the other end of the cable to the audio output jacks on your video source.

2

Using the Projector

Once you've connected the projector to your computer or other equipment (as described in Chapter 1), you're ready to turn on the projector, adjust the image, and give your presentation.

Although you can operate the projector without it, the remote control lets you use additional features. See Chapter 3 for instructions on using the remote. This chapter covers the following:

- Turning on the projector and other equipment
- Adjusting the image
- Controlling the projector
- Shutting down the projector

Turning On Your Equipment

Make sure your projector and other equipment are set up and connected correctly, as described in Chapter 1 or Appendix A. Then turn on your projector, as described below, followed by any equipment you've connected to it. You can turn on your computer and video equipment in any order, but if you have more than one computer or video source connected, you may have to switch to the desired source as described on page 27.

Turning On the Projector

Follow these steps to plug in and turn on the projector:

1. Connect one end of the power cord to the projector's power inlet.

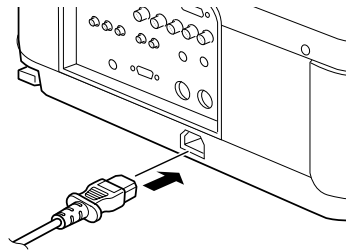

2. Connect the other end to a grounded electrical outlet.

The power light on the projector's control panel turns orange, indicating that the projector is receiving power but not yet turned on.

3. Remove the lens cap.

4. Press the red **Power** button on top of the projector.

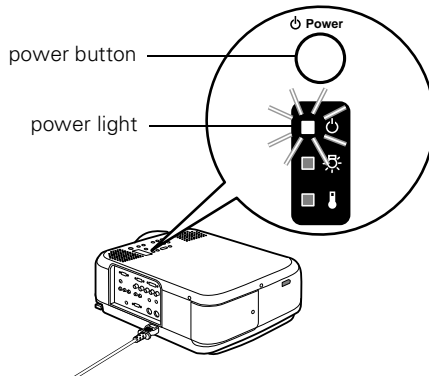

The power light flashes green as the projector warms up, and the projection lamp comes on in about 30 seconds. The power light stays green, and you may see a blue screen with the message **No Signal** displayed. This is normal.

5. Do one of the following:
 - Turn on or restart your computer. In a few moments, you should see your computer display projected.
(Windows only: If you see a New Hardware Found message saying that it has found a plug-and-play monitor, click **Cancel**.)
 - If you're projecting a video, press the **Play** button on your video source.

If a projected image fails to appear, see the next section for help.

Once you see your image, turn to page 24 for instructions on focusing and making other image adjustments.

When you're done with your presentation, shut down the projector as described on page 28. Shutting down the projector correctly prevents premature lamp failure and possible damage to the projector from overheating.

warning

Never look into the lens when the lamp is on. This can damage your eyes, and is especially dangerous for children.

What To Do If You See a Blank Screen

If you see a blank screen or a blue screen with the message **No Signal** after turning on your computer or video source, do one of the following:

- Make sure the cables are connected correctly, as described on page 12 (for laptops) or in Appendix A (for other systems).
- Make sure the power light is green and not flashing and the lens cover is off.
- Try restarting your computer.
- If you've connected more than one computer and/or video source, you may need to press the **Computer** or **Video** button on top of the projector to select the correct source. (Allow a few seconds for the projector to sync up after pressing the button.)

If you're using a PowerBook:

You may need to set up your system to display on the projector screen as well as the LCD screen. Follow these steps:

1. From the Apple menu, select **Control Panels**, then click **Monitors and Sound**.
2. Click the **Arrange** icon.

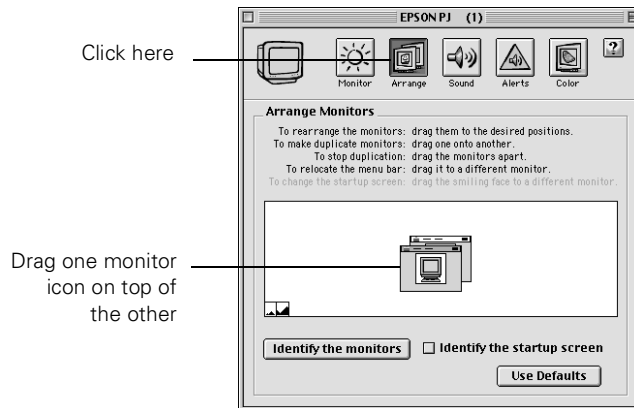

3. Drag one monitor icon on top of the other.

If this option isn't available, you may need to select one of the Simulscan resolution settings:

1. Click the **Monitor** icon.

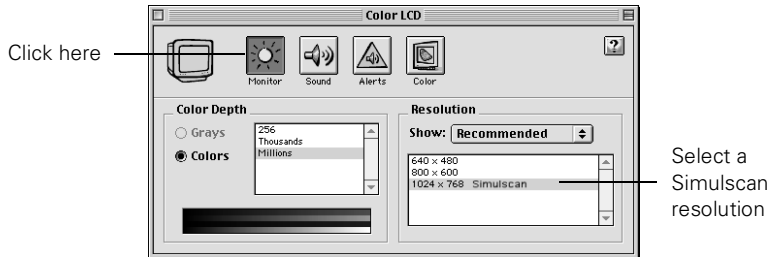

2. Select a **Simulscan** resolution as shown. (Allow a few seconds for the projector to sync up after making the selection.)

If you're using a PC laptop:

- Press the function key that lets you display on an external monitor. It's often labelled with an icon such as  but it may also be labelled **CRT/LCD**. You may have to hold down the **Fn** key while pressing it. Check your laptop's manual or online help for details.

On most systems, the  key lets you toggle between the LCD screen and the projector, or display on both at the same time. Allow a few seconds for the projector to sync up after pressing it.

- Depending on your computer's video card, you might need to use the Display utility in the Control Panel to make sure that both the LCD screen and external monitor port are enabled. See your computer's documentation or online help for details.

Adjusting the Image

Once you see your image, you'll need to make certain adjustments:

- To focus or zoom your image, see below.
- If only part of a computer image is displayed, you may need to press the **Resize** button. See page 25 for more information.
- If the image is too high or too low, you can reposition it. See page 25.
- If the image isn't square, see page 26.
- If the projected image is flickering or "noisy," see page 26.

Focusing and Zooming Your Image

Rotate the focus ring to sharpen the image.

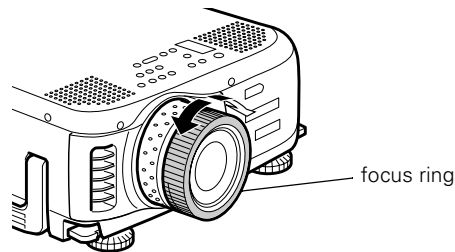

Rotate the zoom ring to reduce or enlarge the image.

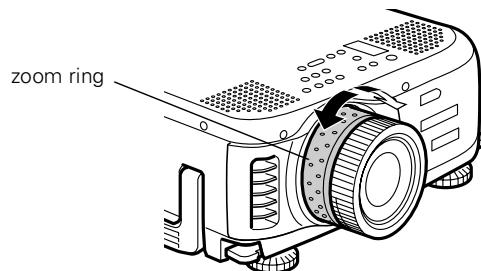

If the image still isn't large enough, you may need to move the projector farther away from the screen. You can also use the **E-Zoom** button on the remote control to zoom in on a portion of the image. See page 33 for instructions.

Resizing the Image

Some computer images need to be resized to display in the projector's native format: 1024 × 768 pixels. If only part of your computer image is displayed, you can correct it with the **Resize** button.

- Press the **Resize** button on the control panel. The screen image is automatically compressed.
- Continue pressing the **Resize** button to pan around the screen in the original resolution.

If you're projecting from video equipment, pressing the **Resize** button switches the aspect ratio between 4:3 and 16:9. If you've zoomed in on your image (using the **E-Zoom** button on the remote), you can press the **Resize** button to return it to the original display size.

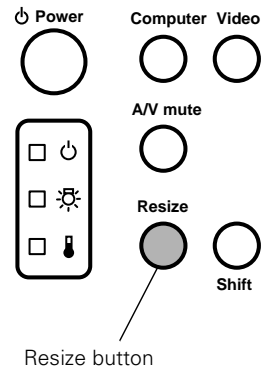

Adjusting the Height of Your Image

If the image is too low, you can raise it by extending the projector's feet.

1. Stand behind the projector. Pull up the blue foot release levers and lift the front of the projector. This unlocks the feet.

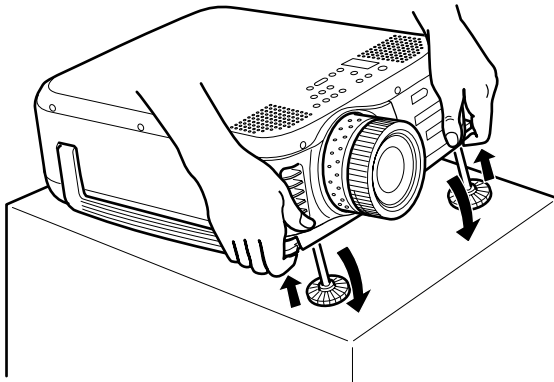

2. Once the image is positioned where you want it, release the levers to lock the feet in position.
3. To fine-tune the height of the image, rotate the thumb wheels attached to the projector's feet.





If the image is no longer square after raising it, see the next section.

caution

Do not hold the projector by the lens; this can damage it.

Adjusting the Image Shape

If the projected image isn't square or has a "keystone" shape, do one or more of the following:

- If your image looks like  or , you've placed the projector off to one side of the screen, at an angle. Move it directly in front of the center of the screen, facing the screen squarely.
- If your image looks like  or , press the + or - side of the **Keystone** button to correct the shape of the image. After correction, your image will be slightly smaller.

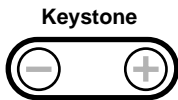

You can also perform electronic keystone correction using the projector's Setting menu. See page 52.

Adjusting the Tracking and Synchronization

If you're projecting from a computer and you notice vertical stripes or the image is flickering or noisy, you can increase the clarity by pressing the  button on the control panel (or the **Auto** button on the remote control). This resets the projector's tracking, sync, and position settings. If necessary, you can also correct the image manually using the **Tracking** and **Sync** buttons on the control panel.

- Press the **Tracking -** and **Tracking +** buttons to eliminate vertical stripes.

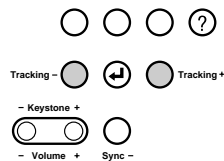
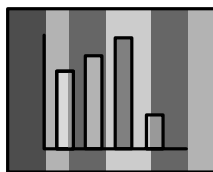

- Press the **Sync -** and **Sync +** buttons to eliminate flashing, blurring, or vertical noise on the screen image.

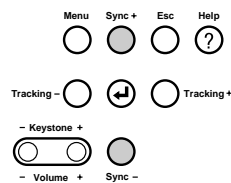
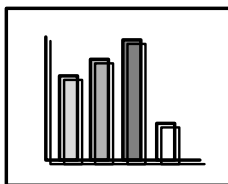

note

Images will be projected more vividly if you adjust the Tracking before adjusting the Sync.

Controlling the Projector

While giving your presentation, you may want to switch between picture sources, adjust the volume, or temporarily turn off the picture and sound. Follow the instructions below to access these features from your projector's control panel. You can also access these features, as well as many others, by using the remote control as described in Chapter 3.

Switching Between Picture Sources

If your projector is connected to more than one computer and/or video source, you can use the buttons on the control panel (or remote control) to switch between the different sources.

On the control panel, press the **Computer** button to switch between the computer sources and press the **Video** button to switch between standard (composite) video, S-Video, and component video (BNC).

After you select a source, the screen goes dark for a moment before the image appears.

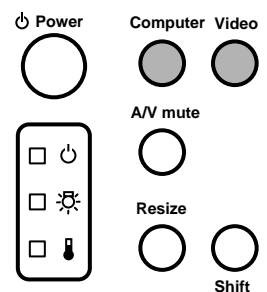

Adjusting the Volume

If your presentation includes sound, you can adjust the volume with the **Volume** button on the projector's control panel. Hold the **Shift** button down while pressing the + or - side of the **Volume** button.

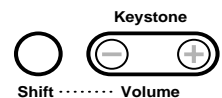

Turning Off the Picture and Sound

You can use the **A/V Mute** button on the control panel to turn off the image and sound and darken your screen. This is useful if you want to temporarily re-direct your audience's attention without the distraction of a bright screen.

- To turn off the picture, press the **A/V Mute** button. The screen goes dark.
- To turn the image back on, press the button again.

note

You can also have an image, such as a company logo, display on the screen whenever you press the **A/V Mute** button. See page 49 for instructions.

Shutting Down the Projector

note

When the projector has not received any input signals for 30 minutes, it automatically turns off the projector lamp and enters “sleep mode.” This conserves electricity, cools the projector, and extends the life of the lamp. If you are done using the projector, unplug the power cord. If you want to start projecting again, press the Power button.

When you’ve finished using the projector, follow the recommended procedure to shut it down. This extends the life of the lamp and protects the projector from possible overheating.

1. If you’ve connected a computer or laptop and it’s displaying only through the projector (the computer’s monitor is disconnected or turned off), shut down the computer first; otherwise you won’t be able to see your computer’s display if you try turning it off after the projector.
2. To turn off the projector, press the red Power button on the projector or remote control. You see a confirmation message. (If you don’t want to turn it off, press any other button.)

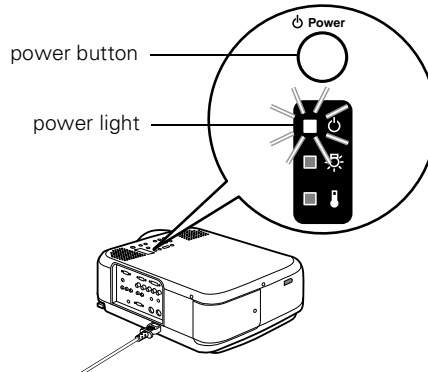

3. Press the Power button again. The power light flashes orange for about a minute as the projector cools down. When the projector has cooled, the orange light stays on and the exhaust fan shuts off.
If you want to turn the projector on again, wait until the orange light stops flashing. Then press the Power button.
4. Replace the lens cap and unplug the power cord.
5. If you’re using a VCR or other video source, turn it off after you turn off the projector.
6. Disconnect all equipment, and store the projector in a protective case.

caution

To avoid damaging the projector or lamp, never unplug the power cord when the power light is green or flashing orange.

3 *Using the Remote Control*

The remote control lets you access your projector's features from anywhere in the room—up to 30 feet away. You can use it to turn the projector on and off, control the picture and sound, and highlight your presentation by using it as a digital pointer.

If you've connected the mouse cable (as described in Chapter 1 or Appendix A), you can even use the remote control as a wireless mouse to control your computer or click through your slideshow-style presentations.

This chapter covers the following information:

- Turning on and using the remote control
- Controlling the picture and sound
- Highlighting your presentation
- Using the remote control as a wireless mouse

Turning On and Using the Remote Control

Before using the remote control, you need to install its batteries and turn it on as described below.

caution

When replacing batteries, take the following precautions:

- Don't mix old and new batteries.
- Replace batteries as soon as they run out. If the batteries leak, wipe away battery fluid with a soft cloth. If fluid gets on your hands, wash them immediately.
- Remove batteries if you won't be using the projector for a long period of time.

Installing Batteries

Follow these steps to install or replace the batteries:

1. Press the tab to release the battery compartment cover.

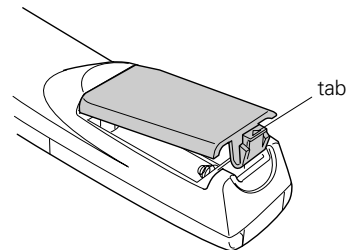

2. Remove the cover and insert the two AA batteries included with the projector as shown.

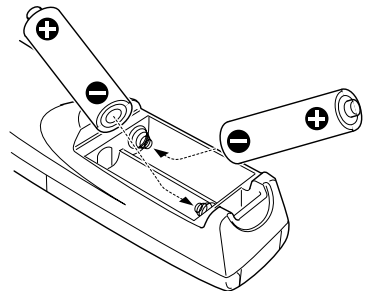

3. Replace the battery compartment cover.

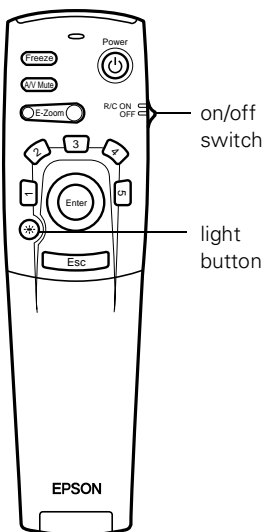

Turning On the Remote Control

Make sure batteries are installed. Then push up the on/off switch on the side of the remote control to turn it on.

If you want to make sure the batteries are good, press the round  light button. The other buttons on the remote should light up temporarily. If they don't, you need to change the batteries as described above.

Using the Remote Control

When using the remote control, stand within about 30 feet of the projector. Point the remote control either at the front or back of the projector or at the screen (the projector's front sensor can detect signals bounced off the screen).

- Press the button for the function you want to use. See the following pages for instructions.
- For some functions, you need to use the **Enter** button like a mouse to navigate on the screen. Press the edge of the button with your thumb—or grasp it between your thumb and finger and tilt it in the direction you want to move.
- To access additional buttons, pull down the cover below the **Esc** button.

Controlling the Picture and Sound

You can use the remote control to select your source, adjust the volume, temporarily turn off the picture and sound, freeze the action, zoom in on the picture, or display a picture-in-picture video image. Make sure you have set up your projector and connected your audio or video source as described in Chapter 1 or Appendix A.

Switching Between Picture Sources

If you've connected your projector to more than one computer and/or video source, you can use the buttons on the remote control (or the control panel) to switch between the different sources.

- Press the **Video** button to switch between a standard composite video source and an S-Video source.
- Press the **Comp1** button to select your first computer.
- Press the **Comp2/YCbCr** button to select your second computer or a component video source.

After you select a source, the screen goes dark for a moment before the image appears.

Adjusting the Volume

If you've connected an audio source to the projector, you can adjust the sound that's output through the projector's speakers.

- To increase the volume, press on the right (+) side of the **Volume** button.
- To reduce the volume, press on the left (-) side of the **Volume** button.

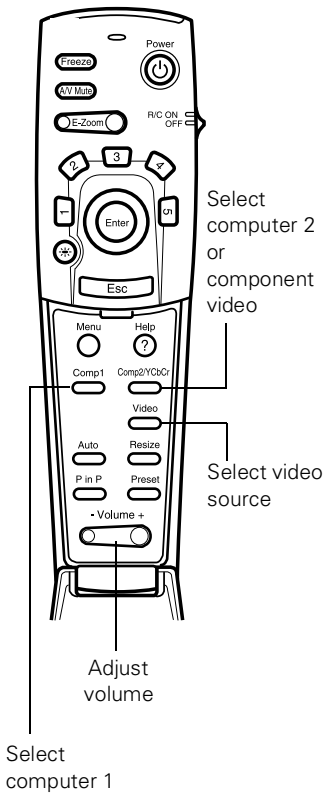

Turning Off the Picture and Sound

You can use the A/V Mute button on the remote control to turn off the image and sound and darken your screen. This is useful if you want to temporarily re-direct your audience's attention without the distraction of a bright screen.

- To turn off the picture, press the A/V Mute button. The screen goes dark.
- To turn the image back on, press the button again.

Stopping Action

You can use the remote control to stop the action in your video or computer image.

- Press the Freeze button to stop the action and keep the current image on the screen. The sound will continue.
- Press the Freeze button again to re-start it.

Zooming Your Image

You can zoom in on a portion of the image using the E-Zoom button on the remote control.

1. Press the right side of the E-Zoom button to zoom in on your image.
 - Press the button repeatedly to enlarge it up to four times in 24 steps.
 - Press and hold the button to zoom in to the size you want.
2. Use the Enter button to pan around the screen if necessary.
3. Press the left side of the E-Zoom button to zoom out. You can press the button repeatedly, or press and hold to zoom all the way out. You can also press the Resize button to return to the original size.

note

You can also have an image, such as a company logo, display on the screen whenever you press the A/V Mute button. See page 49 for instructions.

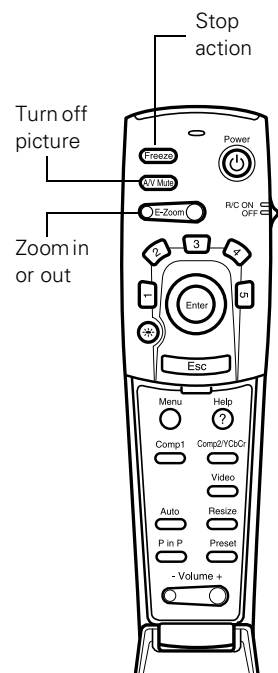

Displaying Picture-in-Picture Video

You can open a small video window on your computer image, and view a video at the same time as your computer presentation.

First make sure you have connected your VCR or other video source using an RCA or S-Video cable as described in Chapter 1. (You can't display the picture-in-picture window using component video.) If you're using S-Video, you need to select it in the P in P menu option as described on page 52.

1. Press the P in P button on the remote control. The screen may go dark for a moment, and then your video image appears in a small window on the screen. A menu appears in the lower left corner of the screen, describing how to move and resize the image.
2. Use the Enter button to reposition the video window on the screen. You can use the E-ZOOM button to enlarge or reduce the video window.
3. When the window is located and sized the way you want, press the Enter button. The menu disappears, and your video plays on the screen.

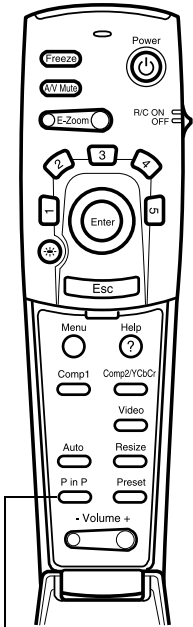

Display picture in picture



video window

4. When you're finished viewing the picture-in-picture, press the P in P button again. The video window disappears.

Highlighting Your Presentation

You can highlight areas on the screen using the numbered buttons on the remote control. You can use these “special effects” features to annotate your presentation slides or call attention to your most important points. Five highlighting tools are available:

- Pointer or cursor stamp (button 1)
- Box (button 2)
- Spotlight (button 3)
- Bar (button 4)
- Erase (button 5)

You can customize the highlighting tools through the Effect menu. See page 47 for instructions.

Using the Pointer

You can choose from three types of pointers and place them anywhere on your screen.

1. To activate the pointer tool, press button 1 on the remote control. A  green pointer appears in the upper left corner of the screen. To try a different look, press 1 again. Press 1 again to see the third one.
2. Use the **Enter** button to place the pointer wherever you want it.
3. To “paste” the pointer on the screen, press down in the center of the **Enter** button. You can then continue to work with another pointer, moving it around the screen or pasting it wherever you want.
4. To erase the pointers pasted on the screen, press button 5.
5. To cancel the pointer feature, press **Esc**.

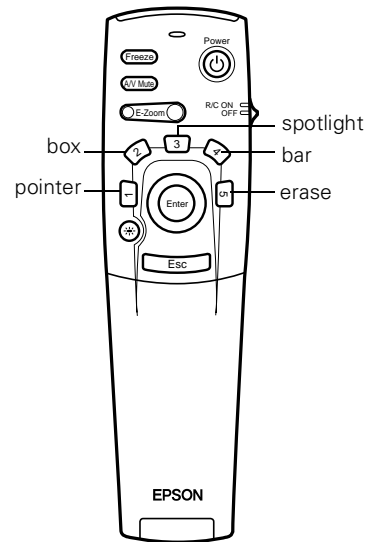

note

You can use the projector's Effect menu to select different pointers. See page 47.

Using Box Highlights

You can draw outline boxes on the screen to highlight areas of your presentation or video.

note

You can use the projector's Effect menu to change the color and shape of the box. See page 47.

1. To activate the box tool, press button 2 on the remote control. A  pink square appears in the upper left corner of the screen. This is the box-drawing tool.
2. Use the **Enter** button to place the square where you want to begin drawing the box.
3. Press down in the center of the **Enter** button. You see a corner mark on the screen; this defines one corner of the box.
4. Use the **Enter** button to drag the square to where you want the opposite corner of the box to be.
5. Press down in the center of the **Enter** button. You see the box outlined on the screen.

You can continue placing boxes on the screen by repeating steps 2 through 5.

6. To erase the box(es), press button 5.
7. To cancel the box drawing feature, press **Esc**.

Spotlighting Your Image

With the Spotlight tool, you can place a square highlight on part of the screen image.

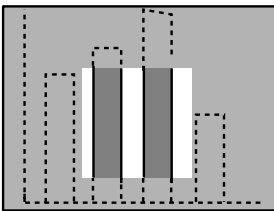

1. To activate the spotlight tool, press button 3 on the remote control. A box of light appears on part of the image. You can continue pressing button 3 to change to three different spotlight sizes.
2. Use the **Enter** button to move the spotlight where you want it to be.
3. To remove the spotlight, press **Esc**.

You can change the default size of the Spotlight using the Effect menu; see page 47.

Using Horizontal and Vertical Highlights

With the bar tool, you can draw bold horizontal or vertical lines on the screen to underline or highlight your presentation points. You can choose from three types of bars.

1. To activate the bar tool, press button **4** on the remote control. A horizontal bar appears across the screen. If you want a vertical bar, press **4** again. If you want to try another horizontal bar, press **4** again.
2. Use the **Enter** button to move the bar up and down the screen (or left and right if you are using the vertical bar).
3. To cancel the bar drawing feature, press **Esc**.

note

You can change the color and width of the bars using the Effect menu. See page 47.

Using the Remote Control as a Wireless Mouse

When you use the remote control as a wireless mouse, you can control your computer or click through slideshow-style presentations (such as PowerPoint) from up to 30 feet away. This gives you more flexibility, since you won't need to stand near your computer to change slides, for example.

First make sure you have connected the mouse cable between the projector and your computer as described on page 13 (for laptops) or in Appendix A (for other systems). Note that your computer's mouse may be disabled when you connect the projector's mouse cable. If you have a laptop, you won't be able to use an external mouse; however, you may still be able to use the computer's built-in mouse pointer.

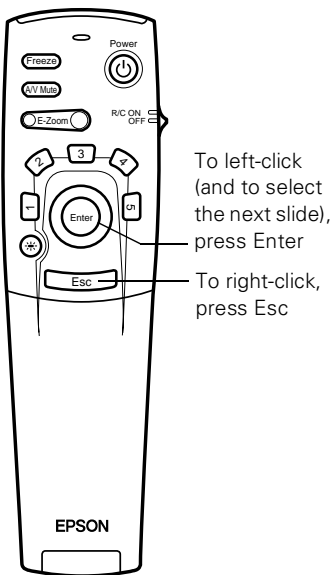

- To move the mouse pointer on the screen, aim the remote at the screen and press on the edge of the **Enter** button with your thumb—or grasp it between your thumb and finger and tilt it in the direction you want to move. This button works like the mouse button on many laptop keyboards.
- To click (or left-click), press down on the center of the **Enter** button. This changes slides in a PowerPoint presentation when you're in Slide Show mode.
- To right-click, press the **Esc** button.
- To double-click, press down twice on the **Enter** button.
- To click and drag, press down on the **Enter** button and then tilt it in the direction you want to drag.

4

Fine-tuning the Projector

You can use the projector's on-screen menus to adjust the image, sound, and other features. You can also create your own startup screen, customize the highlighting tools, and find out how long your lamp has been in use. This chapter covers the following information:

- Using the menu system
- Adjusting the image
- Adjusting the sound
- Customizing the highlighting controls
- Creating your own startup screen
- Customizing projector features
- Viewing lamp usage and other information
- Restoring the default settings

Using the Projector's Menu System

The eight projector menus let you adjust and customize the projector features from either the remote control or control panel:

- The Video menu controls the look and quality of the projected image. It lets you adjust the image position and fine-tune settings such as Brightness, Sharpness, and Contrast.
- The Audio menu controls the volume level, treble, and bass settings.
- The Effect menu lets you change the cursor speed and modify the highlighting tools available on the remote control.
- The Setting menu allows you to set or adjust features such as the Picture in Picture (P in P) video source, blank screen color, A/V Mute display option, and sleep mode.
- The Capture menu lets you capture and store a custom image or logo which you can then use as a startup screen or with the A/V Mute option.
- The Advanced menu lets you specify additional projector settings, including menu language, startup screen, color setting, and rear or ceiling projection.
- The About menu provides information about lamp status and computer or video settings.
- The Reset All menu lets you restore the factory defaults for all the projector settings.

Changing Menu Settings

You can use the buttons on the control panel or remote control to access the menus and change settings. Follow these steps:

1. To display the menu screen, press the **Menu** button on the control panel or the remote control.

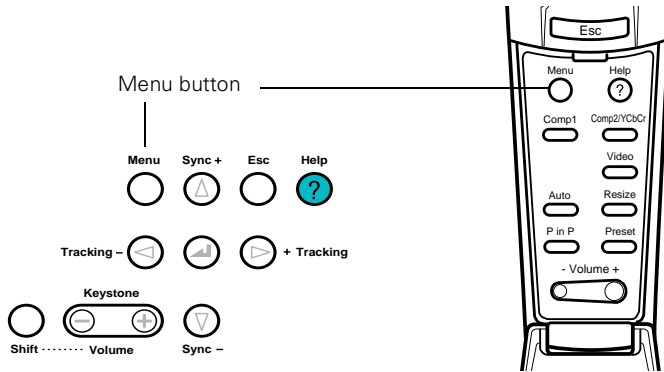

You see the menu screen:

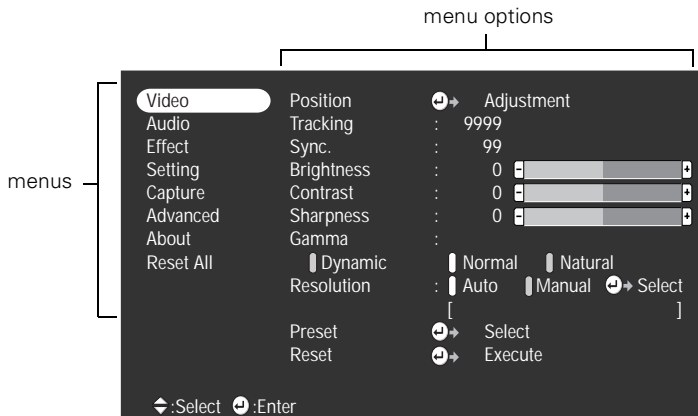

The eight menus are listed on the left, and the options available for the highlighted menu are shown on the right.

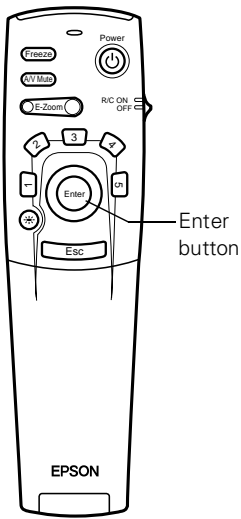

2. Press the up or down arrows (control panel) or press up or down on the **Enter** button (remote control) to scroll through the menu list.

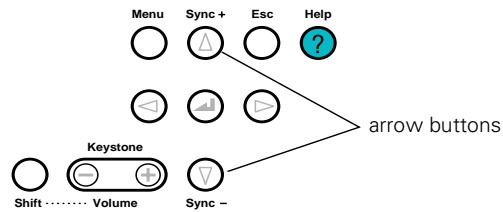

3. When the menu you want is highlighted, press the **Enter** button to select it. The highlight moves to the first option for that menu.
4. Use the arrow buttons (control panel) or the **Enter** button (remote control) to scroll through the list of options. (If a computer or video source isn't connected, certain options may be unavailable.)
5. Use the arrow buttons (control panel) or the **Enter** button (remote control) to change the setting for the selected option. Enabled settings are indicated by a green light, while disabled ones are blank.
6. Press the **Esc** button to return to the main menu. Your changes are saved automatically.
7. Press **Esc** again (or the **Menu** button) to exit the menu system.

note

*If you want to go back to the default settings on any menu, select **Reset**, press **Enter**, select **Yes**, and then press **Enter**.*

Adjusting the Image

The Video menu lets you make adjustments to the projected image. The options available in the menu depend on which source is connected to the projector: standard computer video, computer digital video, composite or S-Video, or component video.

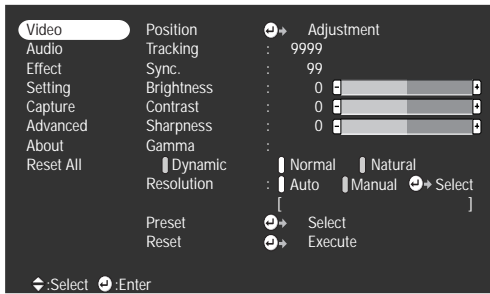

Video menu for standard computer display



Video menu for DVI computer display

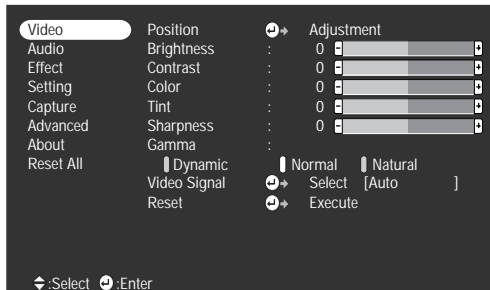

Video menu for composite video or S-Video



Video menu for component video

note

*If you have repositioned the image or adjusted the sync setting, you can use the **Auto** button on the remote control to restore the default settings.*

Repositioning the Image

Follow these steps to fine-tune the image position:

1. Press the **Menu** button. You see the main menu.
2. Press **Enter** to select the Video menu.
3. Press **Enter** to select the **Position** option. You see the following on the right side of the screen:
4. Use the arrow buttons (control panel) or the **Enter** button (remote control) to move the image left, right, up, or down.
5. When the image is positioned the way you want, press **Esc**.

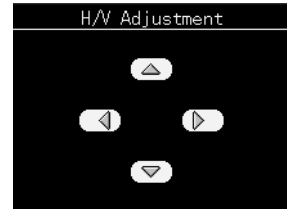

Adjusting Image Appearance

Follow these steps to adjust the appearance of your image:

1. Press the **Menu** button. You see the main menu.
2. Press **Enter** to select the Video menu.
3. Use the arrow buttons (control panel) or the **Enter** button (remote control) to set one of the following options:
 - **Brightness**
Lightens or darkens the overall image.
 - **Contrast**
Adjusts the difference between light and dark areas.
 - **Tracking (computer images only)**
Removes unwanted vertical lines from a computer image by matching the projector's internal clock to various computer signals.
 - **Sync (computer images only)**
Corrects fuzziness or screen flicker by synchronizing the projector with the tracking signal sent from the computer.
 - **Color (composite video or S-Video only)**
Adjusts the depth or intensity of the image.

- **Tint (video only)**
Adjusts the balance of green to magenta in the image.
 - **Sharpness**
 - **Gamma**
Choose **Dynamic** for computer images with bright colors (such as charts or graphs), or **Natural** to enhance video images.
 - **Resolution (computer images only)**
Leave this setting at **Auto** to allow the projector to detect the video signal automatically. If the projector is unable to sync up with the computer, select **Manual** and choose from 32 settings.
 - **Video Signal**
Leave this setting at **Auto** unless you are using a 60-hertz PAL system (select **PAL60**).
4. When the image is set correctly, press **Esc**. Your settings are automatically saved.

Saving and Recalling Computer Settings

When you are projecting from a computer source, you can save and recall settings (resolution, tracking, sync signal, and position) for up to five different sessions. This is useful if you use more than one computer with the projector; you can save the settings for each one and recall them when necessary. Follow these steps to save the current session settings:

1. Press the **Menu** button to display the Main menu.
2. Press **Enter** to select the Video menu.
3. Use the down arrow (control panel) or **Enter** button (remote control) to move down to the **Preset** option and press **Enter**. You see the Preset Selection menu with the current resolution setting displayed.

note

*If you want to overwrite an existing setting, move to the setting and press **Enter**. When the confirmation message appears, choose **Yes** and press **Enter**.*

4. Press **Enter** to assign it to the next available number.
5. Press **Enter** again. When you see the “Overwrite?” prompt, select **Yes** or **No** and press **Enter**.
6. Press **Esc** to return to the Video menu.

When you want to use a saved setting, press the **Preset** button on the remote control. You see the setting for session number 1 displayed in yellow at the top right of the screen.

To select another number, press the **Preset** button again until the setting number you want is displayed. The projector resets according to the selected setting.

Adjusting the Sound

You can use the Audio menu to adjust the sound volume or treble/bass balance.

1. Press the **Menu** button. You see the main menu.
2. Press the down arrow (control panel) or press down on the **Enter** button (remote control) to highlight **Audio**. You see the following:

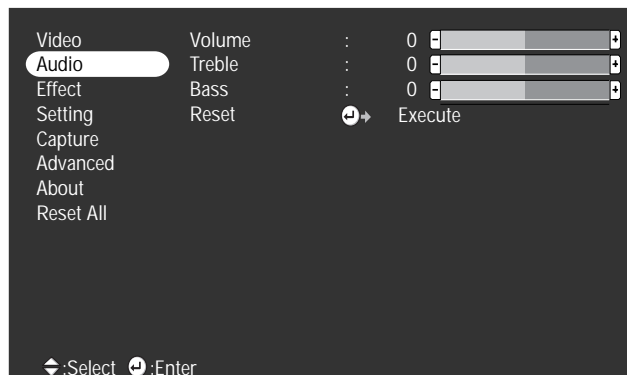

3. Press **Enter** to select the Audio menu.

4. Use the arrow buttons (control panel) or the **Enter** button (remote control) to set the following options:
 - Volume
 - Treble
 - Bass
5. When you're finished adjusting the sound, press **Esc** or **Menu**.

Customizing the Highlighting Tools

The highlighting tools let you add pointers and other types of annotations to your image, as described on pages 35 to 37. You can use the **Effect** menu to customize these tools and set the cursor speed for highlighting. The **Reset** option lets you return all the highlighting tools to their default settings.

1. Press the **Menu** button. You see the main menu.
2. Use the down arrow button (control panel) or the **Enter** button (remote control) to highlight **Effect**. You see the Effect menu:

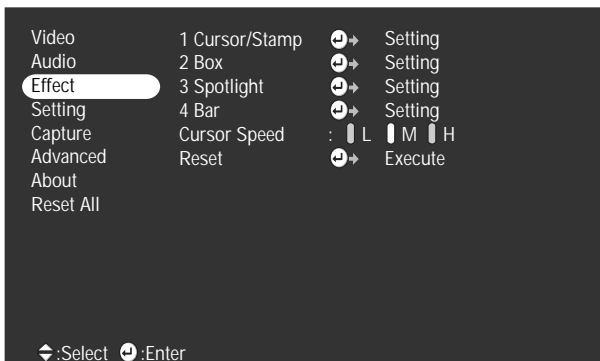

3. Press **Enter** to select the **Effect** menu.

4. Use the arrow buttons (control panel) or the **Enter** button to customize:
 - **Cursor/Stamp**
Lets you define the shape and size for three different pointers. For some pointers, you can also define the color and length.
 - **Box**
Lets you define the box color and choose from a solid or outline box, with rounded or square corners.
 - **Spotlight**
Lets you choose a large, medium, or small spotlight.
 - **Bar**
Lets you define three different bars. For each one, you can set the color and width, and choose between vertical and horizontal.
5. Use the arrow buttons (control panel) or the **Enter** button (remote control) to make your selections.
6. When you're finished customizing the highlighting tools, press **Esc**. Your selection(s) are saved.

Creating Your Own Startup Screen

You can transfer any image on your computer to the projector, and then use it as the screen displayed when the projector is not receiving a signal. You can also set it to be displayed when you press the **A/V Mute** button, or as a startup screen. The image can be a company logo, slogan, photograph, or any other image you want to use.

Capturing the Image

Start by displaying the image you want to use on the projector. You can use an image from either a computer or video source such as a VCR or digital camera. Then follow these steps to capture the image and transfer it to the projector:

1. Press the **Menu** button on the control panel or remote control. You see the main menu.
2. Press the down arrow (control panel) or press down on the **Enter** button to highlight the **Capture** menu.

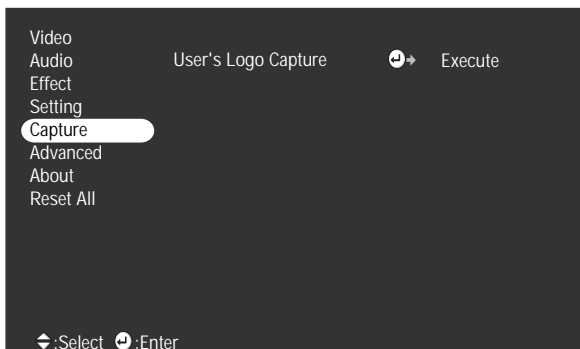

3. Press **Enter** to highlight **User's Logo Capture** and press **Enter** again to select it. You see the message shown at the right.
4. Select **Yes** and press **Enter**. A selection box displays over the image.
5. Use the arrow buttons on the control panel or the **Enter** button on the remote control to select the area of the image you want to use. Once you have selected the entire area, press **Enter**.



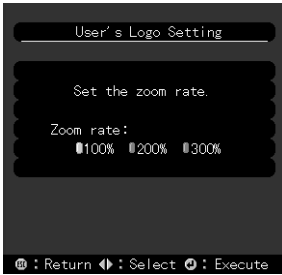

6. When you see the message “Do you use this image?” select **Yes** and press **Enter**. If you want to change the area selected, select **No**, press **Enter** and repeat steps 4 through 6. You see the message shown at the left.
7. Use the arrow buttons on the control panel or the **Enter** button on the remote control to select a zoom rate (display size), and then press **Enter**.
8. When the message “Do you save this image?” appears, select **Yes** and press **Enter**.

Saving the logo may take a few moments. Do not use the projector or other sources (computer, video, speaker, etc.) while the logo is being saved.
9. When you see the message “Saving the user logo is completed,” press the **Menu** or **Enter** button to return to the Capture menu. Then press **Esc** to return to the main menu.

note

You can also set up your image as a startup screen. Use the Advanced menu to enable the startup screen; see page 53.

Setting Up When the Image Displays

After your image is saved, you can set it up as the no-signal message and/or the screen that’s displayed when you press the **A/V Mute** button.

1. Press the **Menu** button to display the main menu (if not already displayed).
2. Press the down arrow (control panel) or press down on the **Enter** button (remote control) to highlight the **Setting** menu.
3. Press the **Enter** button to select the Setting menu.
4. Press the down arrow (control panel) or press down on the **Enter** button (remote control) to highlight **No-Signal Msg**.
5. Press the right arrow or use the **Enter** button to select **Logo**. This sets your image as the screen displayed when the projector is not receiving a signal.
6. If you want to set up your image as the A/V Mute display, use the down arrow or **Enter** button move down to **A/V Mute**.

7. Press the right arrow or use the **Enter** button to select **Logo**. This sets your image as the screen displayed when you press the **A/V Mute** button.
8. When you're finished, press **Esc** or **Menu**.

To test your setting, press the **A/V Mute** button to display your image. Press it again to turn off the image.

Customizing Projector Features

You can use the Setting menu to disable the projector's sleep mode, adjust the image shape, and customize several other features.

1. Press the **Menu** button.
2. Use the arrow keys (control panel) or the **Enter** button (remote control) to highlight **Setting**. You see the features and their settings on the right side:

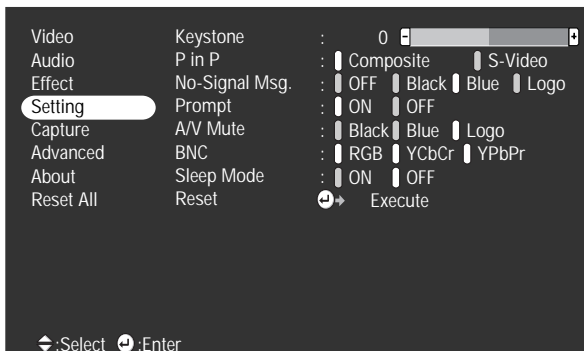

3. Press **Enter** to select the Setting menu.

4. Use the arrow buttons (control panel) or the **Enter** button (remote control) to set the following options:
 - **Keystone**
Adjusts a distorted image from a trapezoid shape to rectangular.
 - **P in P**
Changes from a composite (standard) video source to an S-Video source for the picture-in-picture display.
 - **No-Signal Msg**
Selects the screen color and message to display when the projector is not receiving a signal. The logo setting displays an image that you have transferred to the projector. See page 49 for instructions on transferring an image to use as the no-signal message.
 - **Prompt**
Turns off the identifying text that appears briefly when you switch from computer input to a video source.
 - **A/V Mute**
Selects the screen color or image to display when you press the **A/V Mute** button. The logo setting displays an image that you have transferred to the projector. See page 49 for instructions on transferring an image to use for the A/V Mute display.
 - **BNC**
Specifies the format for input to the BNC connectors. If the source is a computer, select **RGB**. If the source is a video device, select **YCrCb**.
 - **Sleep mode**
Disables the power management system. Normally, the lamp turns off when the projector has not received any input signals for 30 minutes.
5. When you're finished, press **Esc**.

Setting Advanced Features

You can use the Advanced menu to configure the projector for rear projection or ceiling mounting, and adjust several other features.

1. Press the **Menu** button.
2. Use the arrow keys (control panel) or the **Enter** button (remote control) to highlight **Advanced**. You see the features and their settings on the right side:

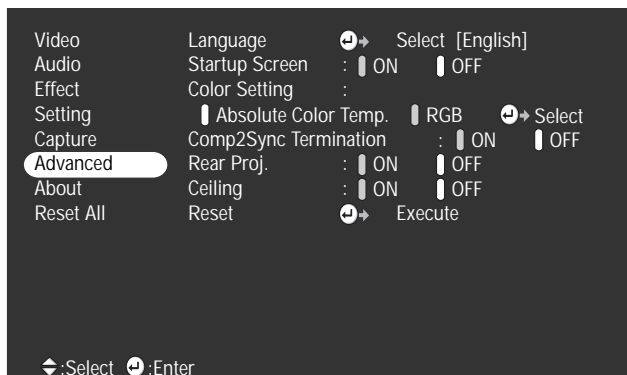

3. Press **Enter** to select the Advanced menu.
4. Use the arrow buttons (control panel) or the **Enter** button (remote control) to set the following options:
 - **Language**
Select from 9 languages to be used for the projector menus.
 - **Startup Screen**
Turn on to display the image or logo you have captured whenever the projector starts. See page 49 for more information.
 - **Color Setting**
Adjusts the color temperature of the projected image. Select **Absolute Color Temp.** to set a temperature between 5000 and 10000 K. Select **RGB** to adjust individual red, green, and blue values, as shown.

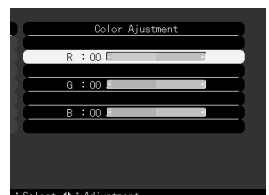

- **Comp2Sync Termination**
Used for testing. Leave the setting on for normal operation.
- **Rear Proj.**
Turn on to project from behind onto a transparent screen.
- **Ceiling**
Turn on when the projector is mounted upside-down from the ceiling.

5. When you're finished, press **Esc**.

Viewing Lamp Usage and Other Information

Use the About menu to view information about the display settings of your computer and the number of hours the lamp has been used.

note

If you access the About menu when the projector display is set to video, you only see the lamp life and the video signal setting.

1. Press the **Menu** button. You see the main menu.
2. Use the arrow buttons (control panel) or the **Enter** button (remote control) to select **About**.

You see the lamp usage hours and computer display settings on the right:

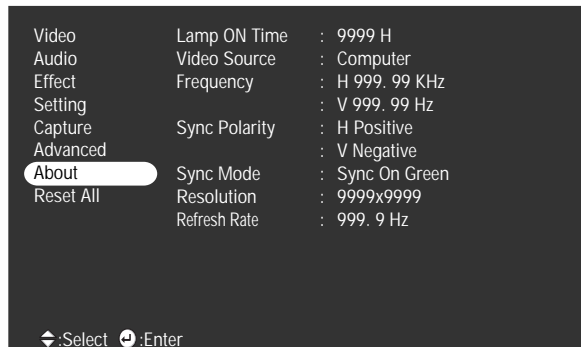

The life span of the lamp is about 1500 hours. If the number shown is close to 1500, make sure you have a spare lamp handy.

3. When you're finished, press **Esc**.

Restoring the Default Settings

The Reset All option lets you return all the projector settings to their default values.

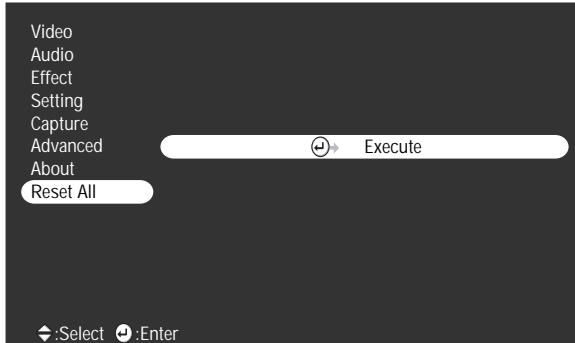

Select **Reset All** and press the **Enter** button on the control button or remote control to display the confirmation screen. Select **Yes** to reset all the default settings or **No** to cancel.

5 *Maintaining and Transporting the Projector*

Your projector needs little maintenance. All you need to do on a regular basis is keep the lens clean. Any dirt or smears on the lens may show up on your projected image.

warning

Before you clean any part of the projector, turn it off and unplug the power cord. Never open any cover on the projector, except the lamp and filter covers. Dangerous electrical voltages in the projector can injure you severely. Do not try to service this product yourself, except as specifically explained in this User's Guide. Refer all other servicing to qualified service personnel.

You also need to periodically clean the air filter on the bottom of the projector. A clogged air filter can block ventilation needed to cool the projector and keep it from overheating.

The only parts you should replace are the lamp and air filter. If any other part needs replacing, contact your dealer or a qualified service person.

This chapter covers the following:

- Cleaning the lens
- Cleaning the projector case
- Cleaning and replacing the air filter
- Replacing the lamp
- Transporting the projector

Cleaning the Lens

Clean the lens whenever you notice dirt or dust on the surface.

- Use a canister of compressed air to remove dust.
- To remove dirt or smears on the lens, use lens-cleaning paper. If necessary, moisten a soft cloth with lens cleaner and gently wipe the lens surface.

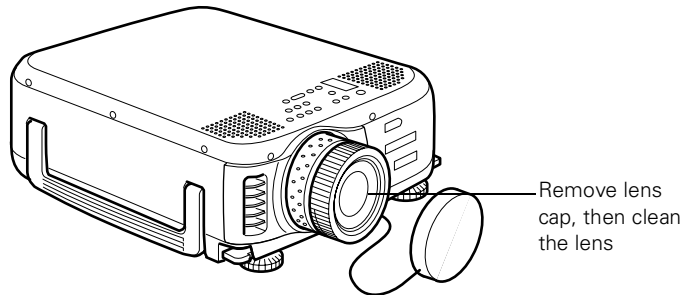

Cleaning the Projector Case

Before you clean the case, first turn off the projector and unplug the power cord.

- To remove dirt or dust, wipe the case with a soft, dry, lint-free cloth.
- To remove stubborn dirt or stains, moisten a soft cloth with water and a neutral detergent. Then wipe the case.
- Do not use alcohol, benzene, thinner, or other chemical detergents. These can damage the case.

Cleaning and Replacing the Air Filter

Clean the air filter at the bottom of the projector after every 100 hours of use. If it is not cleaned periodically, it can become clogged with dust, preventing proper ventilation. This can cause overheating and damage the projector. To clean the air filter, follow these steps:

1. Turn off the projector, allow it to cool down, and unplug the power cord.
2. Turn the projector on its side so that the handle is on top and you can access the filter easily.
3. To clean the filter, EPSON recommends using a small vacuum cleaner designed for computers and other office equipment. If you don't have one, gently clean the filter using a very soft brush (such as an artist's camel-hair brush).

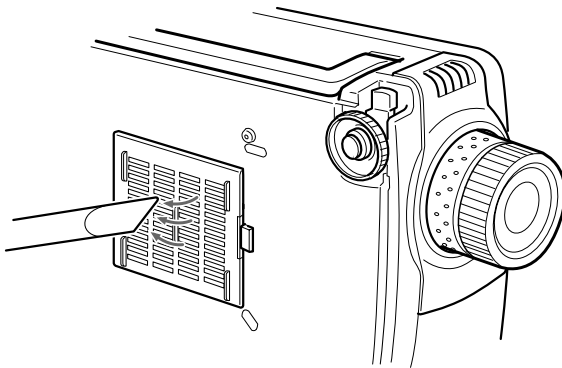

If the dirt is difficult to remove or if the filter is torn, replace it. Contact your dealer or call EPSON at (800) 873-7766 in the United States and Canada to obtain a new one.

note

When you get a replacement lamp for your projector, a new air filter is included. You should replace the filter when you replace the lamp.

4. If you need to replace the filter, pull on the catch to remove it. Make sure the projector is on its side as shown (not turned upside down) to prevent dust from falling inside.

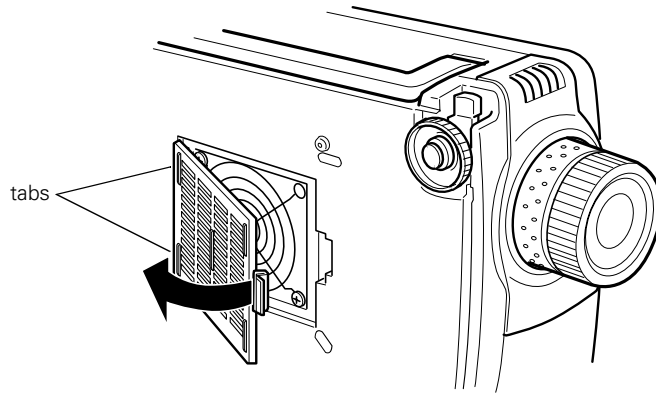

5. To install the new filter, first insert the tabs, then press on the catch until it clicks in place.

Replacing the Lamp

note

You can check to see how many hours the lamp has been used. See page 54.

The projection lamp typically lasts for about 1500 hours of use. It is time to replace the lamp when:

- The projection image gets darker or starts to deteriorate.
- The lamp warning light  is flashing red or orange.
- The message **LAMP REPLACE** appears on the screen when the projector lamp comes on (after about 1400 hours of use). To maintain projector brightness and image quality, replace the lamp as soon as possible.

Contact your dealer or call EPSON at (800) 873-7766 in the United States and Canada for a replacement lamp. Request part number ELPLP12.

Follow these steps to replace the lamp:

1. Turn off the projector and unplug the power cord.
2. Allow the projector to cool down for at least an hour (if it has been on).
3. Use a screwdriver to loosen the retaining screw on the lamp cover. (You can't remove the screw from the cover.)

When the screw is loose, slide off the lamp cover.

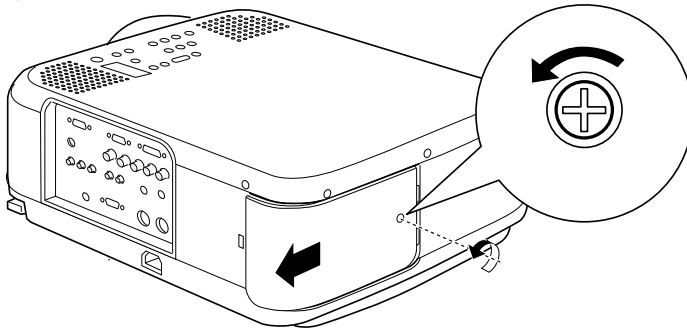

4. Use a screwdriver to loosen the two screws holding the lamp in place. (You can't remove these screws.)
5. Lift up the wire handle, as shown, and pull the lamp straight out. (The plastic flap above the lamp will flex out of the way as you remove the lamp.)

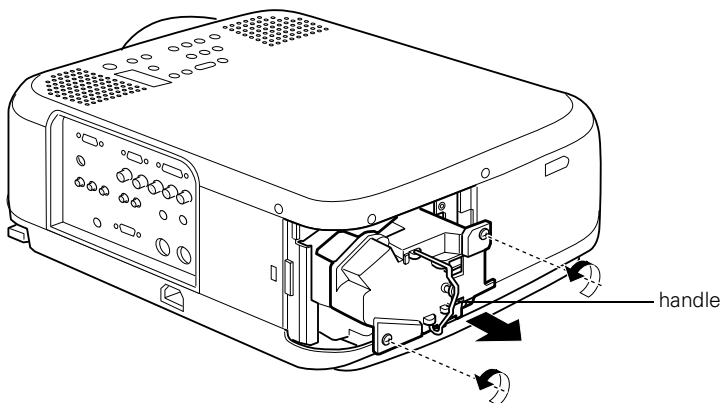

warning

Let the lamp cool before replacing it. If the lamp breaks, handle the shards carefully to avoid injury.

caution

Do not touch the glass portion of the lamp assembly. Touching the glass could result in premature lamp failure.

6. Fully insert the new lamp. (The plastic flap will flex out of the way.)

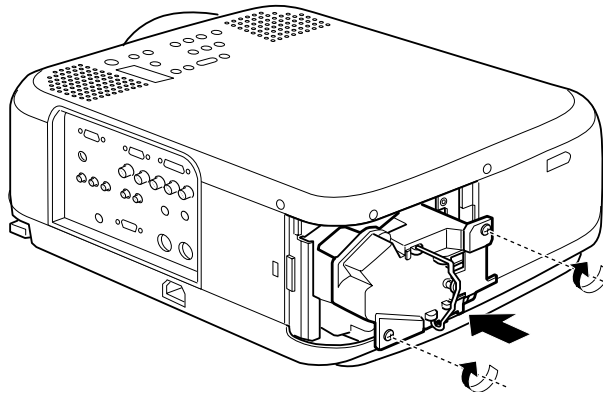

7. Once the lamp is fully inserted, tighten its screws.
8. Replace the lamp cover and tighten its screw securely. (The projector won't come on if the lamp cover is loose.)
9. Reset the lamp timer as described in the following section.

Resetting the Lamp Timer

After you install a new lamp, you need to reset the timer so the projector can keep track of how many hours it has been used. Follow these steps:

1. Press the **Help** button and hold it down for at least 5 seconds.

You see the Help menu, and then the following message:



2. Use the left arrow button (control panel) or press left on the **Enter** button (remote control) to select **Yes**.
3. Press **Enter** to reset the timer.

Transporting the Projector

The projector contains many glass and precision parts. If you need to transport it, please follow these packing guidelines to prevent damage to the projector:

- When shipping the projector for repairs, use the original packaging material if possible. If you do not have the original packaging, use equivalent materials, placing plenty of cushioning around the projector.
- When transporting the projector for business use, first put it in a hard-shell carrying case (such as the optional EPSON case), then pack it in a firm box, using cushioning around the case.
- When you are hand-carrying the projector, be sure to store it in a carrying case (such as the optional cases offered by EPSON).

note

EPSON shall not be liable for any damages incurred during transportation.

6 *Solving Problems*

This chapter helps you solve problems with your projector, and tells you how to contact technical support for problems you can't solve yourself. This chapter explains the following:

- Using the projector's on-screen help system
- What to do when the projector's status lights flash
- Solving problems with the image or sound
- Solving problems with the remote control
- Contacting technical support

Using On-Screen Help

If you see a **No Signal** message or your audio isn't working, you can get help by pressing the blue **? Help** button on top of the projector or under the cover on the remote control. The following choices are available:

- **Help for the image**
Tells you what to do if you see a **No Signal** message
- **Help for the sound**
Tells you what to do when your audio isn't working
- **Language selection**
Lets you display the help information and projector menus in any of nine different languages

Follow these steps to get help:

1. Press the blue **? Help** button. You see the help menu.
2. Use the **▲** up or **▼** down arrow buttons on the control panel (or move the **Enter** button up or down on the remote control) to highlight one of the options. Then press the **↵** or **Enter** button to select it.
3. Press the **↵** or **Enter** button again to view the solutions. (Press **Esc** if you need to back up.)
4. Press the down arrow button on the control panel (or press down on the **Enter** button on the remote control) to display additional text.
5. To exit the Help system, press the blue **? Help** button.

If none of the suggestions solves your problem, see additional solutions to problems in the following sections.

caution

*Don't hold the **? Help** button for more than 5 seconds, or the projector will enter the mode for resetting the lamp timer.*

What To Do When the Lights Flash

The lights on top of the projector indicate the projector's status and let you know when a problem occurs.

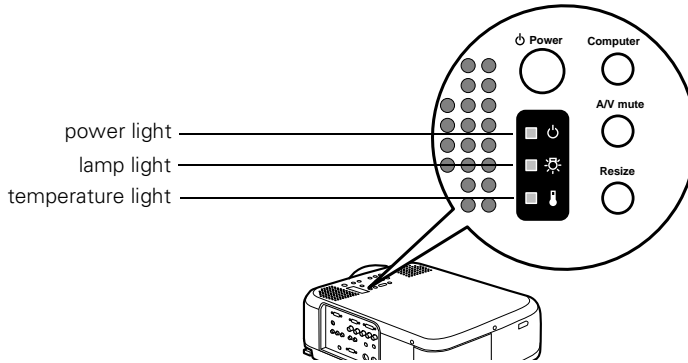

If the projector is not working correctly, first turn it off and unplug it. Then plug the power cord back in and turn on the projector. If this does not solve the problem, check the status lights on top of the projector and try the solutions recommended below.

The  power light is flashing orange and you cannot turn on the projector.

The lamp is cooling down. Wait until the light turns off and then press the **Power** button to turn on the projector.

The  power light does not come on.

Make sure the power cord is connected securely both at the power outlet and the projector.

The  lamp warning light is flashing red.

Replace the lamp as described on page 60. If you have just replaced the lamp, make sure the cover is securely fastened.







The temperature light is flashing orange.



- The projector is getting too hot. Turn it off and let it cool. Make sure the room temperature does not exceed 104 °F and there is plenty of space around and under the projector for ventilation.
- The air filter may be clogged. Clean or replace it as described on page 59.

The temperature light is red.

- The projector has overheated. Turn it off and let the projector cool for a few minutes, then turn it back on. Make sure the room temperature is not above 104 °F and there is plenty of space around and under the projector for ventilation.
- The air filter may be clogged. Clean or replace it as described on page 59.
- If the projector continues to overheat after you clean the air filter, the problem may be caused by damage to the cooling fan or internal circuits. Contact EPSON for help.

Refer to the table below for a complete description of the projector's status lights and their meaning:

Light	Status	Description
	orange	The projector is in sleep mode. You can unplug it or press the Power button to turn it on.
	flashing green	The projector is warming up. Wait for the image to appear.
	green	The projector is operating normally.
	flashing orange	The projector is cooling down. You can't turn it back on (nor should you unplug it) until the lamp stops flashing and remains orange.
	red	Power is cut off because of an internal problem. Remove the power cord and contact EPSON for help.
	flashing orange	The lamp is almost burned out. This is a good time to replace it. See Chapter 5 for instructions.
	flashing red	The lamp is burned out. Replace it as described on page 60. If you have just replaced the lamp, make sure the cover is fastened securely.

Light	Status	Description
	flashing orange	The projector is getting too hot. Turn it off and let it cool. Make sure the temperature surrounding the projector does not exceed 104 °F and there is plenty of space around and under the projector for ventilation. Clean the air filter if necessary.
	red	The projector has overheated and turned itself off. Let it cool for a few minutes, then turn it back on. Make sure there is plenty of space around and under the projector for ventilation. If it continues to overheat, you may need to change the air filter. See page 59 for instructions.
	flashing red	There is a problem with the cooling fan or temperature sensor. Turn off the projector and unplug it. Contact EPSON for help.

Solving Problems with the Image or Sound

No image appears on the screen.

- Check that the power light is green, not flashing, and the lens cover is off.
- The projector may be in sleep mode. If the power light is orange, press the **Power** button to turn the projector on.
- If the power was switched off and then on again, the projector may still be cooling down. Wait until the power light stops flashing and remains orange; then press the **Power** button again.
- Make sure the **Brightness** setting on the Video menu is correct. See page 43 for more information. Try selecting the **Reset All** setting to return all setup menus to their default values.
- Press the **A/V Mute** button to make sure the picture has not been turned off temporarily.
- The attached computer may be in sleep mode or displaying a black screen saver. Try pressing a key on the computer.

You see a blue screen with the message No Signal displayed.

- Make sure the cables are connected correctly, as described in Chapter 1 or Appendix A.
- Try restarting your computer.
- If you've connected more than one computer and/or video source, you may need to press the **Computer** or **Video** button (on the control panel) or the **Comp1**, **Comp2/YCbCr**, or **Video** button (on the remote control) to select the correct source. Allow a few seconds for the projector to sync up after pressing the button.
- If you've connected a second computer or you're using component video, make sure the **BNC** option in the Setting menu is correct. See page 52 for more information.
- Make sure the **Computer 1** selector switch on the projector's interface panel is set to **Analog** (for standard computer video) or **Digital** (for a computer using DVI video). See page 12.

If you're using a PC laptop:

- Press the function key that lets you display on an external monitor. It's often labelled with an icon such as  but it may also be labelled **CRT/LCD**. You may have to hold down the **Fn** key while pressing it. Check your laptop's manual or online help for details.

On most systems, the  key lets you toggle between the LCD screen and the projector, or to display on both at the same time. Allow a few seconds for the projector to sync up after pressing it.

- Depending on your computer's video card, you might need to use the Display utility in the Control Panel to make sure that both the LCD screen and external monitor port are enabled. See your computer's documentation or online help for details.

If you're using a PowerBook:

1. From the Apple menu, select **Control Panels**, then click **Monitors and Sound**.
2. Click the **Arrange** icon.

3. Drag one monitor icon on top of the other. This lets you display on the projector screen as well as the LCD screen.
4. If this option isn't available, click the **Monitor** icon.
5. Select one of the listed **Simulscan** resolutions. (Allow a few seconds for the projector to sync up after making the selection.)

The message Not Supported is displayed.

Make sure your computer's resolution doesn't exceed UXGA (1,600 × 1,200), and the frequency is supported by the projector (see page 99). If necessary, change your computer's resolution setting as described below.

Only part of the computer image is displayed.

- Press the **Resize** button on the control panel or remote control.
- Make sure the image **Position** setting is correct on the Video menu. See page 44 for more information.
- If the right or left side of the image is cut off, you may need to adjust the tracking using the buttons on the control panel. Hold down the + or – **Tracking** button to change the setting until the image looks correct.
- Make sure your computer's resolution setting is correct. Ideally, it should be 1024 × 768 to match the projector's native resolution. If this option isn't available, select one of the other compatible video formats listed on page 99.
 - **Windows:**
Right-click the desktop, select **Properties**, click the **Settings** tab, and use the dialog box to select a different resolution.
 - **Macintosh:**
On the Apple menu, choose **Control Panels**, then click **Monitors and Sound**. Select a different resolution.
- You also may need to modify existing presentation files if you created them for a different resolution. See your software documentation for specific information.

The image isn't square, but trapezoid-shaped.

- Make sure the projector isn't placed off to one side of the screen, at an angle, or the image won't be square. Place the projector directly in front of the center of the screen, facing the screen squarely.
- If you've tilted the projector upward by extending the legs, the image will be broader at the top. Hold down the + or – side of the **Keystone** button on top of the projector until the image is square.

The image is blurry or poor.

- There may be dirt or smears on the lens. Clean the lens as described on page 58.
- Adjust the focus using the focus ring.
- Adjust the settings on the Video menu (see page 44). When you change video settings, you should be able to see the effect on the screen immediately. If you don't like the new settings, you can always select **Reset** to return to the factory default settings.
- If you're using a computer cable longer than 6 feet, or an extension cable, the image quality may be reduced.
- The video signal may be split between the computer and the projector. If you notice a decline in the projected image quality when the image is displayed simultaneously on your laptop computer and the projector, turn off the laptop LCD display.

The image is flickering or “noisy,” or you see vertical lines.

If you're projecting from a computer, try pressing **Auto** on the remote control or **Enter** on the control panel. This resets the computer display settings automatically.

If that doesn't work, you may need to adjust the **Tracking** and **Sync** settings manually using the buttons on the control panel. Hold down each button to change the setting until your image looks correct. It is best to project a gray screen (or the screen you see when you exit Windows) when you adjust these settings.

note

*Images will be projected more vividly if you adjust the **Tracking** before the **Sync**.*



The colors of the image are not right.

- The color balance may be incorrect. If you're displaying a computer image, use the **Gamma** option in the projector's Video menu to adjust the balance of red, green, and blue. If you're displaying video, adjust the **Color**, **Tint**, and **Gamma** settings on the Video menu. Also try adjusting the **Color Setting** option in the Advanced menu.
- Check your computer display settings to correct the color balance.

note

Because of the different technologies used, your projected image may not exactly match the colors on your laptop or computer monitor.

There is no sound.

- Try turning up the volume. Hold down the **Shift** button and press the right side of the **Volume** button (control panel) or press the right side of the **Volume** button (remote control).
- If you're using a VCR or other video source, make sure the volume is not turned all the way down or muted. Also, make sure the cables are connected correctly, as described in Chapter 1.
- If your presentation includes computer audio, make sure the volume control on your computer is not turned all the way down or muted. Make sure the audio cable is securely connected to both the projector and your computer's  headphone jack or  audio out jack. See page 14 (for laptops) or Appendix A (for other systems).
- Make sure the Windows volume controls on your computer are not turned all the way down or set to Mute. You may be able to check this by right-clicking the sound icon on your Windows desktop.
- Make sure the **A/V Mute** button is not enabled.
- The wrong source may be selected. Press the **Computer** or **Video** button on the control panel—or the **Comp1**, **Comp2/YCbCr**, or **Video** button on the remote control—to select the proper source.

Solving Problems with the Remote Control

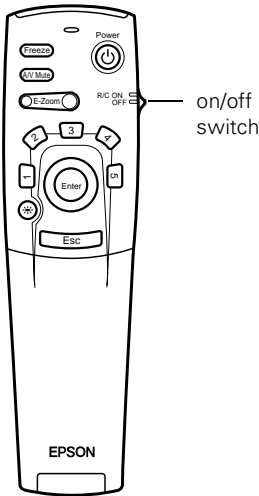

The projector doesn't respond to remote control commands.

- Make sure the remote control is turned on.
- Make sure you are within 30 feet of the projector, and within range of the projector's front or back sensor (approximately 30° to left or right and 15° above or below).
- The remote control batteries may not be installed correctly or may be low on power. To test the batteries, press the ☀ light button. The other buttons on the remote should light up temporarily. If they don't, you need to change the batteries as described on page 30.
- Dim the room lights and turn off any fluorescents. Make sure the projector is not in direct sunlight. Strong lighting, especially fluorescent lights, may affect the projector's infrared receivers.
- Turn off any nearby equipment that emits infrared energy, such as a radiant room heater.

You can't control the mouse pointer with the remote control.

Make sure the mouse cable is securely connected to both your computer's mouse port or USB port and the projector's mouse port. For details, see page 13 (for laptops) or Appendix A (for other systems).

Where To Get Help

EPSON provides technical assistance through electronic support services and automated telephone services 24 hours a day, as listed in the following table.

Electronic support and automated telephone services

Service	Access
World Wide Web	From the Internet, you can reach EPSON's projector page at http://www.epson.com/mul_proj/
Presenters Online	Access tips, templates, training and more at http://www.presentersonline.com
EPSON Internet FTP Site	If you have Internet FTP capability, use your web browser (or other software for FTP downloading) to log onto ftp.epson.com with the user name anonymous and your e-mail address as the password.
EPSON E-Mail Technical Support	To receive technical advice through e-mail, go to http://support.epson.com and complete the form under the troubleshooting tab, as requested.
Automated Telephone Services	A variety of automated help services are available 24 hours a day, seven days a week. To use these services, you must have a touch tone telephone and call (800) 922-8911 .

Telephone Support Services

To use the EPSON PrivateLine Support service, call (800) 637-7661 and enter the PIN on the EPSON PrivateLine Support card included in your *Owner's Kit*. This is the fastest way of speaking to a live representative, and it's free. This service is available 6 AM to 6 PM, Pacific Time, Monday through Friday, for the duration of your warranty period.

You may also speak with a projector support specialist by dialing one of these numbers:

- U.S.: (562) 276-4394, 6 AM to 6 PM, Pacific Time, Monday through Friday
- Canada: (905) 709-3839, 6 AM to 6 PM, Pacific Time, Monday through Friday

Toll or long distance charges may apply.

Before you call, please have the following information ready:

- Product name (EPSON PowerLite 7700p)
- Product serial number (located on the bottom of the projector)
- Computer configuration
- Description of the problem

You can purchase screens, carrying cases, or other accessories from EPSON at (800) 873-7766 or visit the EPSON Store at www.epson.com (U.S. sales only). In Canada, please call (800) 873-7766 for dealer referral.

A

Appendix A: Connecting to Additional Equipment

This appendix explains how to connect the projector to a desktop computer or Macintosh, high-end workstation, more than one computer, or a DVI video source. It also provides guidance on setting up the projector in a permanent installation.

The following information is covered:

- Installing the projector
- Connecting to a PC desktop computer
- Connecting to a desktop Macintosh
- Connecting to a second computer
- Connecting to a high-end workstation
- Connecting to a DVI video source

Installing the Projector

The projector can be installed for three different viewing setups: front projection, ceiling mounting, or rear projection onto a semi-transparent screen, as shown:

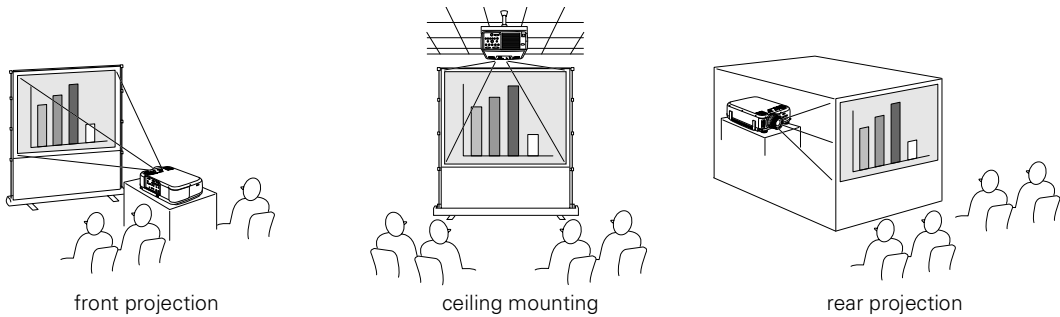

To project from overhead, you'll need to select **Ceiling** in the projector's Advanced menu. To project from the rear, select **Rear Proj.** See "Setting Advanced Features" on page 53.

If you're ceiling-mounting the projector and you place it above screen level, you'll have to tilt it down to position the image on-screen. This causes the image to lose its square shape. You can then correct the distortion by using the **Keystone** function in the projector's menu system (see "Customizing Projector Features" on page 51) or by using the **Keystone** button on the projector's control panel.

If you place the projector's lens so it's level with the top of the screen, the image will be square and you won't have to adjust it. If you place the lens lower than the top of the screen, you'll have to tilt the projector upward if you want to fill the whole screen with the image.

Controlling the Projector from a Computer

If you want to be able to control the projector's settings from a computer, you can install the EMP Link V program on the Projector Software CD-ROM. You'll also need a serial cable to connect the projector to the computer.

To install EMP Link V, insert the Projector Software CD-ROM in your CD-ROM drive and follow the instructions on the screen. The installation program also installs the *EMP Link V User's Guide* on your hard disk. You can access this manual in the EMP Link V folder for complete instructions on using the program.

Connecting to an External Audio System

The projector's internal speakers are loud enough for most rooms. However, if your installation requires maximum volume and sound quality, you can connect the projector to external speakers or a public address (PA) system. If you've connected multiple audio and video sources to the projector, the projector will automatically switch the audio source along with the video source whenever the user chooses a different video source. (See "Switching Between Picture Sources" on page 27 or page 32.)

To connect the projector to an external sound system, you will need an RCA-to-3.5 mm stereo audio cable, which may be included with your sound system, or may be purchased from an electronics store.

Before you start, make sure the projector and speakers or PA system are turned off.

1. Connect the cable's 3.5-mm stereo miniplug to the projector's **Audio Out** jack.

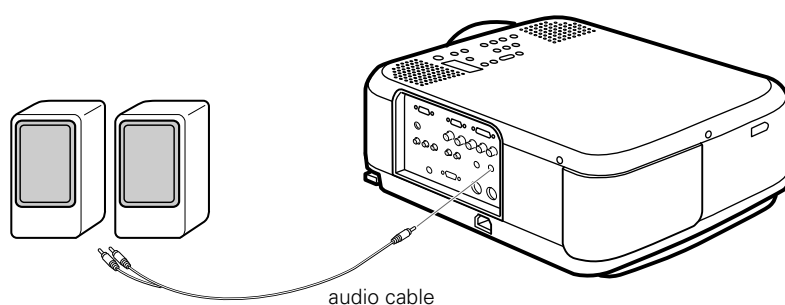

2. Connect the RCA plugs to the speaker or PA system. Insert the cable's red plug into the **Audio R** jack, and the white plug into the **Audio L** jack of the external speaker system.

Connecting to a PC Desktop Computer

You can connect the projector to any IBM compatible PC. This section includes instructions for the following:

- Connecting the computer cable and computer monitor cable
- Connecting the mouse cable (if you want to use the remote control as a mouse)
- Connecting the audio cable (if you'll be projecting with audio)

Follow the steps in each section for the cables you need to connect. Before beginning, turn off the projector and computer if they are on.

Connecting the Computer and Monitor Cables

This illustration shows the connections you'll be making. For details, follow the steps below.

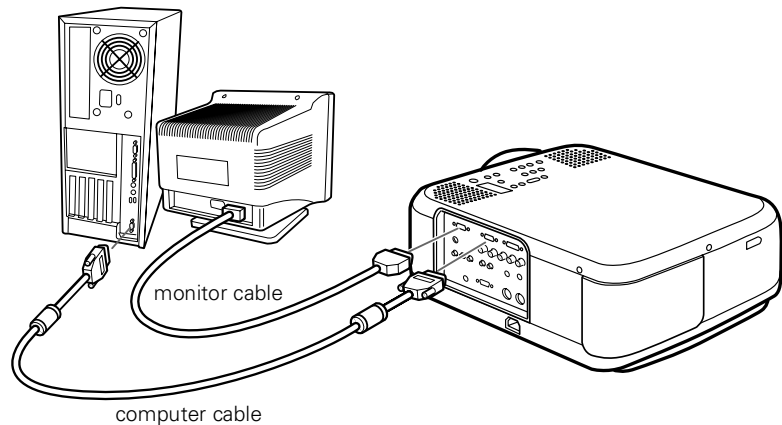

1. Disconnect the monitor cable from the video port on the back of the computer.
2. If you'll be viewing the video on your computer monitor as well as the projector screen, connect the monitor cable to the projector's **Monitor Out** port, as shown. (This is useful when you need to view the video output but the projection screen is behind you.)
3. Connect one end of the computer cable to the projector's **Computer 1** (analog VGA) port.

4. Connect the other end of the computer cable to the computer's video port.
5. Tighten the screws on the connectors.

Connecting the Mouse Cable

To use the remote control as a mouse, follow the steps below. You'll use a different mouse cable, depending on whether your computer has a round PS/2 mouse port or a flat USB port.

1. Connect the round end of the mouse cable to the projector's **Mouse 1** port, as shown.

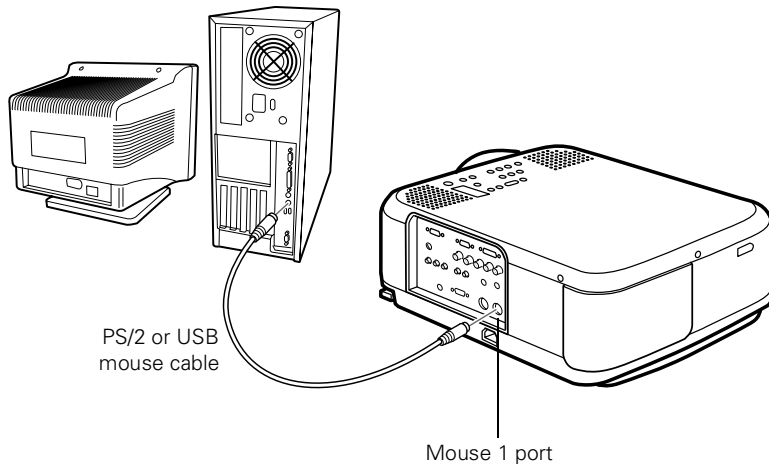

2. Disconnect your mouse from the port on the back of your computer and replace it with the other end of the cable. (Your computer's mouse will be disabled while you are using the remote control as a mouse.)

note

If you have a PC with a serial mouse port, you'll need a serial mouse cable. See your projector dealer to obtain the correct cable.

Connecting the Audio Cable

If your presentation includes sound and you want to use the projector's built-in speakers, you'll need to connect the audio cable.

1. Connect one end of the audio cable to the **Audio (Computer1)** jack on the projector.

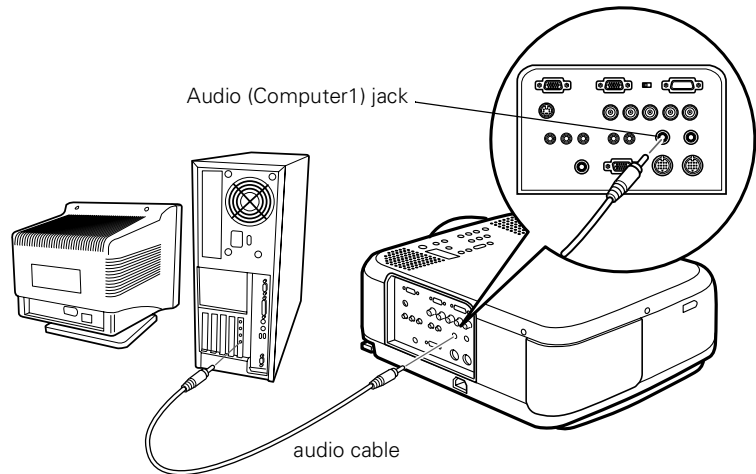

2. Connect the other end of the audio cable to the speaker or audio out port on the computer's sound card.

Connecting to a Desktop Macintosh

You can connect the projector to any desktop Macintosh. This section includes instructions for the following:

- Connecting the computer video cable and computer monitor cable
- Connecting the mouse cable (if you want to use your remote control as a mouse)
- Connecting the audio cable (if you'll be projecting with audio)

Follow the steps in each section for the cables you need to connect. Before beginning, turn off the projector and computer if they are on.

Connecting the Computer and Monitor Cables

This illustration shows the connections you'll be making. (You may not need to use the adapters as shown.) For details, follow the steps below.

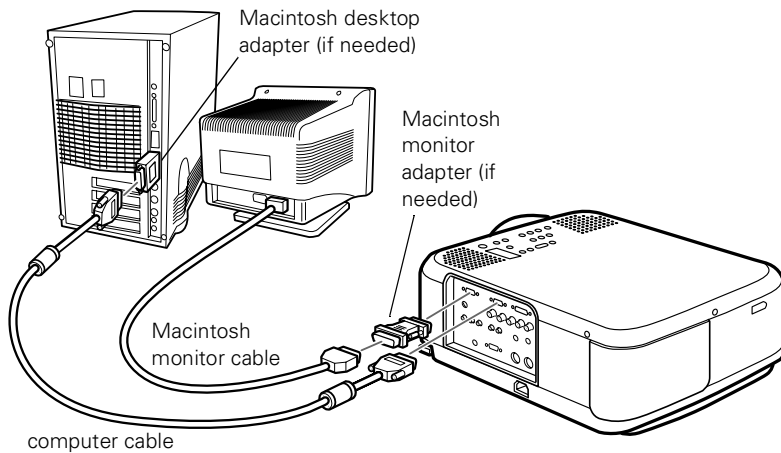

1. Disconnect the monitor cable from the video port on the back of the Macintosh.
2. Connect one end of the computer cable to the projector's Computer 1 port, as shown.

note

Macintosh configurations vary. See your computer manual for the location of the ports needed to connect your projector. Older models may require a Macintosh adapter set, which you may purchase from EPSON; see page 8.

3. Connect the other end of the computer cable to the video port on the Macintosh. If it doesn't fit, you may have to use a Macintosh desktop adapter, which you can buy from EPSON (see page 8).

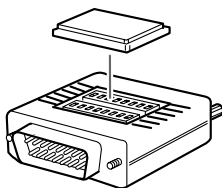

To use the adapter, remove its cover as shown and set its DIP switches according to the resolution you want to use, such as 16-inch mode. See your Macintosh documentation for instructions.

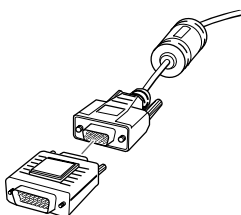

Replace the cover and connect the adapter to the free end of the computer video cable. Then plug the cable (with the adapter) into the video port on your Macintosh.

4. If you also want to view the presentation on your computer's monitor, connect the monitor cable to the projector's **Monitor Out** port. (If necessary, attach a Macintosh monitor adapter to the monitor cable, as shown below, and then connect the adapter to the projector's **Monitor Out** port.)

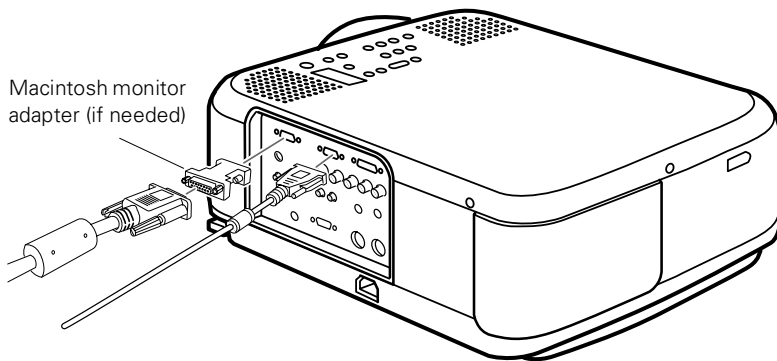

5. Tighten the screws on the connectors.

Connecting the Mouse Cable

To use the remote control as a mouse follow the steps below. If the Macintosh has a USB port, you can use the USB mouse cable included with the projector. If it has a round mouse port, you'll need a Macintosh mouse cable; see your projector dealer for help in obtaining the correct cable.

1. Connect the round end of the USB mouse cable (or a Macintosh mouse cable) to the projector's **Mouse 1** port.

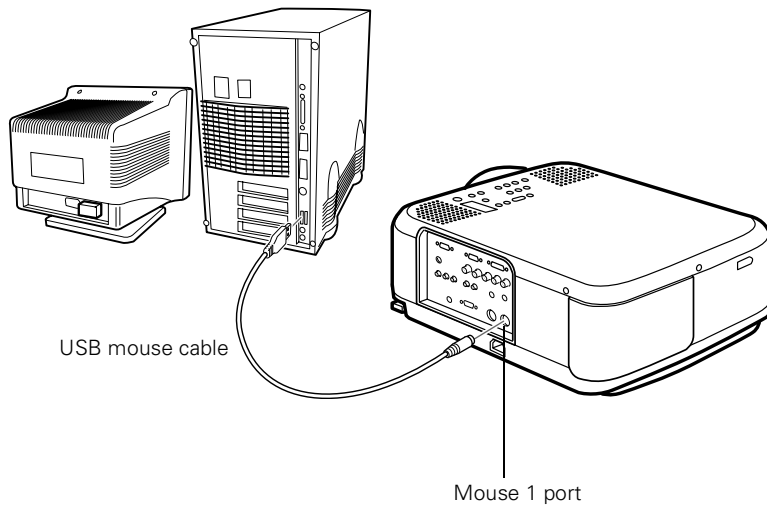

2. Disconnect your Macintosh's mouse cable. Connect the other end of the projector's mouse cable to the mouse or USB port on your Macintosh.

Connecting the Audio Cable

If your presentation includes sound and you want to use the projector's built-in speakers, you'll need to connect the audio cable.

1. Connect one end of the audio cable to the **Audio (Computer1)** port on the projector.

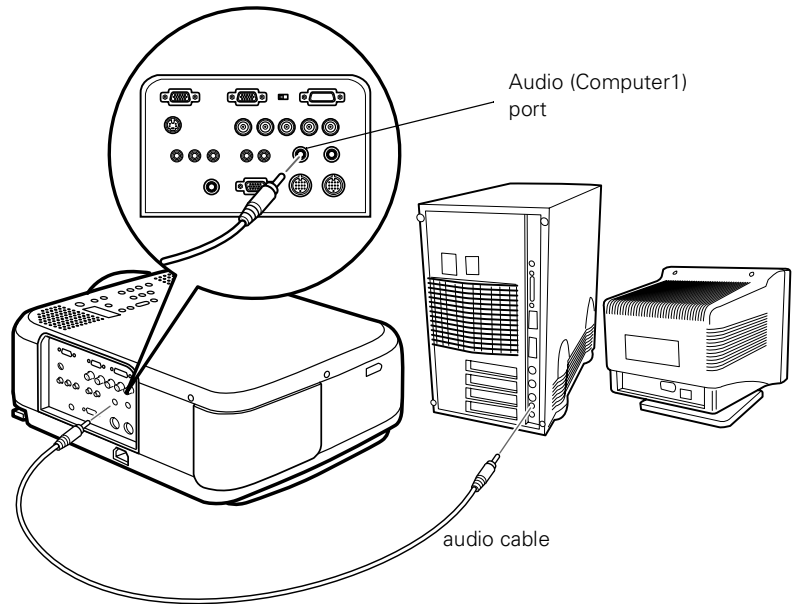

2. Connect the other end of the audio cable to the speaker or audio-out port on the Macintosh.

Connecting to a Second Computer

If you want to connect a second computer to the projector, you need to use the BNC connectors (labelled **Computer 2/Component Video**) on the projector. You'll need a VGA (D-sub 15-pin) to BNC cable, which you can purchase from your computer or electronics dealer.

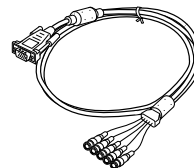

Because these connectors are also used for component video, you can't use a second computer and a component video source at the same time.

Follow these steps to connect a computer to the **Computer 2/Component Video** interface using a BNC cable:

1. Connect the VGA (D-sub 15-pin) end of the cable to the computer's video port.
2. Connect the five connectors at the other end of the cable to the projector's **R/Cr/Pr** (red), **G/Y** (green), **B/Cb/Pb** (blue), **H/CSync** (horizontal sync), and **VSync** (vertical sync) ports, as shown below.

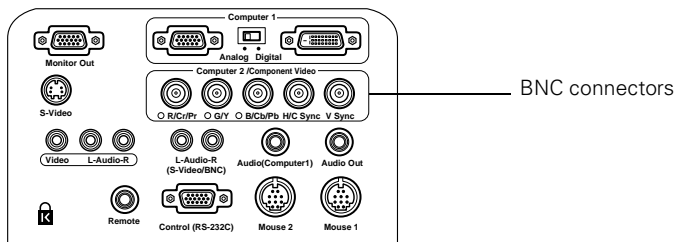

3. To display images properly, make sure the BNC option in the projector's Setting menu is set to **RGB**. See page 52 for instructions.
4. If you want to hear computer-audio through the projector, you'll need an RCA-to-3.5 mm stereo cable (available for purchase from your electronics store or video dealer).

Insert the cable's 3.5-mm plug into your computer's audio-out port. Then attach the RCA connectors at the other end of the cable to the **S-Video/BNC** ports on the projector.

5. If you want to use the remote control as a wireless mouse for the second computer, you need to use either the PS/2 mouse cable or the USB mouse cable that came with the projector.

Connect the round end of the appropriate mouse cable to the **Mouse 2** port on the projector. Then connect the other end of the cable to the computer's mouse or USB port.

Connecting to a High-End Workstation

Your PowerLite projector is capable of remapping input resolutions up to 1600×1200 pixels. Since 1280×1024 pixels is the default resolution for most leading workstations, your projector is ideal for displaying workstation video output.

There is no standard for workstation video output. Workstations that follow the SXGA standard and use the HD15 (standard VGA) connector won't need an adapter cable or any special connection device. However, your system may vary; contact your computer dealer if you need help connecting your workstation.

Connecting to a DVI Video Source

The projector's Digital Visual Interface (DVI) receives pictures directly from your computer in digital format. This lets the projector display images of greater clarity than can be achieved using a standard analog VGA connection.

To project images in digital video format, follow these steps:

1. Connect the computer's DVI cable to the projector's DVI port.

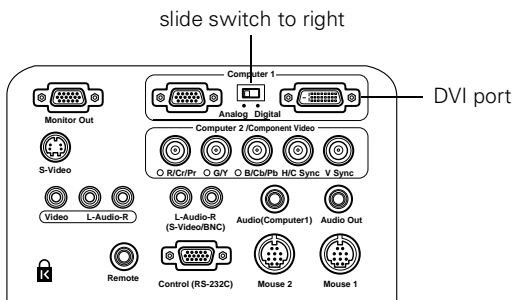

2. Using the tip of a pen or a small screwdriver, slide the Computer 1 interface switch to the right. (If you need to use the projector's analog port again, be sure to slide the switch back to the left.)

If you want to connect audio for this computer, use the projector's Audio (Computer 1) port; if you want to connect a mouse cable (to use the remote control as a wireless mouse), use the Mouse 1 port.

note

You won't be able to view images on a separate monitor when the DVI port is in use.

B

Appendix B: Notices

This appendix includes safety instructions and other important information about your EPSON PowerLite 7700p.

Important Safety Instructions

Follow these safety instructions when setting up and using the projector:

- Do not place the projector on an unstable cart, stand, or table.
- Do not use the projector near water or sources of heat.
- Use attachments only as recommended.
- Use the type of power source indicated on the projector. If you are not sure of the power available, consult your dealer or power company.
- Place the projector near a wall outlet where the plug can be easily unplugged.

Placez le projecteur près d'une prise de contact où la fiche peut être débranchée facilement.

- Insert the projector's three-wire grounding-type plug into a properly grounded outlet. If you have a two-prong outlet, contact an electrician to replace it. Do not hold the plug with wet hands.
- Take the following precautions for the plug. Failure to comply with these precautions could result in sparks or fire: Do not insert the plug into an outlet with dust present. Insert the plug firmly into the outlet.
- Do not overload wall outlets, extension cords, or integral convenience receptacles. This can cause fire or electric shock.

- Do not place the projector where the cord can be walked on. This may result in fraying or damage to the plug.
- Unplug the projector from the wall outlet before cleaning. Use a damp cloth for cleaning. Do not use liquid or aerosol cleaners.
- Do not block the slots and openings in the projector case. They provide ventilation and prevent the projector from overheating. Do not operate the projector on a sofa, rug, or other soft surface, or in a closed-in cabinet unless proper ventilation is provided.
- Never push objects of any kind through cabinet slots. Never spill liquid of any kind into the projector.
- Except as specifically explained in this *User's Guide*, do not attempt to service this product yourself. Refer all servicing to qualified service personnel. Opening or removing covers may expose you to dangerous voltages and other hazards.
- Unplug the projector during lightning storms or when it will not be used for extended periods.
- Do not place the projector and remote control on top of heat-producing equipment or in a hot location.
- Unplug the projector from the wall outlet and refer servicing to qualified service personnel under the following conditions: When the power cord or plug is damaged or frayed. If liquid has been spilled into the projector, or if it has been exposed to rain or water. If it does not operate normally when you follow the operating instructions, or if it exhibits a distinct change in performance, indicating a need for service. If it has been dropped or the housing has been damaged.
- If you use the projector in a country other than where you purchased it, use the correct power cord for that country.

Remote Control Information

You can operate the projector by remote control via a line-of-sight infrared (IR) receiver at the front and rear of the projector. The projector may not respond to remote control commands under the following conditions:

- There is an object between the remote control IR emitter and the IR receiver on the projector.
- Ambient light is too bright.
- Certain types of fluorescent lighting are used.
- A strong light source shines into the IR receiver.
- Other equipment that emits infrared energy, such as a radiant room heater, is in the room.

These conditions commonly cause problems for most infrared-controlled equipment. Try the following:

- The remote control unit's batteries may be low on power; replace them.
- Dim the ambient lighting and/or turn off any fluorescent lights.
- Close any window coverings and/or move the projector out of direct sunlight.
- Turn off other equipment that emits infrared energy.

If the remote control still does not work properly, remember you can always control your computer-based presentation directly from the computer, even in an environment containing one of the conditions listed above.

Declaration of Conformity

According to 47CFR, Part 2 and 15

Class B Personal Computers and Peripherals; and/or
CPU Boards and Power Supplies used with Class B
Personal Computers

We: EPSON AMERICA, INC.
Located at: 3840 Kilroy Airport Way
MS: 6-43
Long Beach, CA 90806-2469
Tel: (562) 290-5254

Declare under sole responsibility that the product identified herein, complies with 47CFR Part 2 and 15 of the FCC rules as a Class B digital device. Each product marketed, is identical to the representative unit tested and found to be compliant with the standards. Records maintained continue to reflect the equipment being produced can be expected to be within the variation accepted, due to quantity production and testing on a statistical basis as required by 47CFR §2.909. Operation is subject to the following two conditions: (1) this device may not cause harmful interference, and (2) this device must accept any interference received, including interference that may cause undesired operation.

Trade Name: EPSON

Type of Product: LCD Projector

Model: EMP-7700/ELP-7700

FCC Compliance Statement

For United States Users

This equipment has been tested and found to comply with the limits for a Class B digital device, pursuant to Part 15 of the FCC Rules. These limits are designed to provide reasonable protection against harmful interference in a residential installation. This equipment generates, uses, and can radiate radio frequency energy and, if not installed and used in accordance with the instructions, may cause harmful interference to radio or television reception. However, there is no guarantee that interference will not occur in a particular installation. If this equipment does cause interference to radio and television reception, which can be determined by turning the equipment off and on, the user is encouraged to try to correct the interference by one or more of the following measures:

- Reorient or relocate the receiving antenna.
- Increase the separation between the equipment and receiver.
- Connect the equipment into an outlet on a circuit different from that to which the receiver is connected.
- Consult the dealer or an experienced radio/TV technician for help.

WARNING

The connection of a non-shielded equipment interface cable to this equipment will invalidate the FCC Certification of this device and may cause interference levels which exceed the limits established by the FCC for this equipment. It is the responsibility of the user to obtain and use a shielded equipment interface cable with this device. If this equipment has more than one interface connector, do not leave cables connected to unused interfaces. Changes or modifications not expressly approved by the manufacturer could void the user's authority to operate the equipment.

For Canadian Users

This Class B digital apparatus meets all requirements of the Canadian Interference-Causing Equipment Regulations.

Cet appareil numérique de la classe B respecte toutes les exigences du Règlement sur le matériel brouilleur du Canada.

C

Appendix C: Technical Specifications

General

Type of display	Poly-silicon Thin Film Transistor (TFT)
Size of liquid crystal panels	Diagonal: 1.3 inches (33.6 mm)
Lens	F=1.7–2.3, f=49–63 mm
Resolution	1024 × 768 pixels (native display format)
Color reproduction	24 bit, 16.7 million colors
Brightness	3000 lumens (ANSI)
Contrast ratio	400:1
Image size	22 to 300 inches
Projection distance	3.6 to 47.6 feet (1.1 to 14.5 meters)
Projection methods	Front, rear, upside-down (ceiling mount)
Internal speaker system	3W × 3W stereo
Optical aspect ratio	4:3 (horizontal : vertical)
Zoom ratio	1:1.3
Noise level	38 dB
Keystone correction angle	± 30° (maximum)

Projection Lamp

Type	UHE (Ultra High Efficiency)
Power consumption	200 W
Lamp life	About 1500 hours
Part number	ELPLP12

Remote Control

Range	32.8 feet (10 meters)
Batteries	Alkaline AA (2)

Mouse Compatibility

Supports PS/2, USB, serial, ADB

Remote IR Receiver

Supports EPSON Remote IR Receiver, 10-foot cable (typical use for rear screen projection)

Dimensions

Height	6.1 inches (156 mm)
Width	11.0 inches (280 mm)
Depth	15.9 inches (403 mm)
Weight	15.2 lb (6.9 kg)

Electrical

Rated frequency	50/60 Hz
Power supply	100 to 120 VAC, 3.4 A 200 to 240 VAC, 1.7 A
Power consumption	Operating: 285 W Standby: 9 W

Environmental

Temperature	Operating: 41 to 104° F (5 to 40° C) Storage: 14 to 140° F (-10 to 60° C)
Humidity	Operating: 20 to 80% RH, non-condensing Storage: 10 to 90% RH, non-condensing

Safety

United States	FCC Part 15B Class B UL1950 Rev. 3
Canada	DOC ICES003 Class B CSA C22.2 No. 950 Rev. 3
CE Marking	Directive 89/336/EEC, 92/31/EEC EN 60950

Compatible Video Formats

The projector supports NTSC, HDTV, PAL, and SECAM international video standards, as well as the monitor display formats listed below.

To project images output from a computer, the computer's video card must be set at a refresh rate (vertical frequency) that's compatible with the projector; see the following table for compatible formats. As noted below, some images are automatically resized to display in one of the projector's "native" formats (such as XGA). In addition, the frequencies of some computers may not allow images to display correctly; see your computer's documentation for details.

Mode	Refresh Rate (Hz)	Resolution
VGACGA	70	640 × 400
VGAEGA	70	640 × 350
VGA60	59.94	640 × 480
VGA72	72.809	640 × 480
VGA75	75	640 × 480
VGA85	85.008	640 × 480

Mode	Refresh Rate (Hz)	Resolution
NEC400	56.65	640 × 400
SVGA56	56.25	800 × 600
SVGA60	60.317	800 × 600
SVGA72	72.188	800 × 600
SVGA75	75	800 × 600
SVGA85	85.061	800 × 600
XGA43i	86.958	1024 × 768
XGA60	60.004	1024 × 768
XGA70	70.069	1024 × 768
XGA75	75.029	1024 × 768
XGA85	84.997	1024 × 768
SXGA1—70	70.012	1152 × 864*
SXGA1—75	75	1152 × 864*
SXGA1—85	84.999	1152 × 864*
SXGA2—60	60	1280 × 960*
SXGA2—75	75	1280 × 960*
SXGA2—85	85.002	1280 × 960*
SXGA3—43i	86.871	1280 × 1024*
SXGA3—60	60.02	1280 × 1024*
SXGA3—75	75.025	1280 × 1024*
SXGA3—85	85.024	1280 × 1024*
UXGA48i	96.08	1600 × 1200*
UXGA60	60	1600 × 1200*
UXGA65	65	1600 × 1200*
UXGA70	70	1600 × 1200*
UXGA75	75	1600 × 1200*
UXGA80	80	1600 × 1200*
UXGA85	85	1600 × 1200*

Mode	Refresh Rate (Hz)	Resolution
MACLC13	66.62	640 × 480
MAC II 13	66.67	640 × 480
MAC16	74.55	832 × 624
MAC19—60	59.28	1024 × 768
MAC19	74.93	1024 × 768
MAC21	75.062	1152 × 870*
HDTV480P (ANSI/SMPTE)	59.94	720 × 483
HDTV480P (ATSC)	59.94	704 × 480
HDTV480I (ANSI/SMPTE)	59.94	720 × 487
HDTV480I (ATSC)	59.94	704 × 480
HDTV720P (SMPTE)	59.94	1280 × 720
HDTV1080P (ANSI/SMPTE)	59.94	1920 × 1080
HDTV480I (ANSI/SMPTE)	59.94	1920 × 1080
NTSC (SVGA)	60	800 × 438
NTSC (XGA)	60	1024 × 438
PAL (SVGA)	50	800 × 512
PAL (XGA)	50	1024 × 512
SECAM (SVGA)	50	800 × 512
SECAM (XGA)	50	1024 × 512

* The image is resized so that it displays using one of the projector's native formats.

Interface Connectors

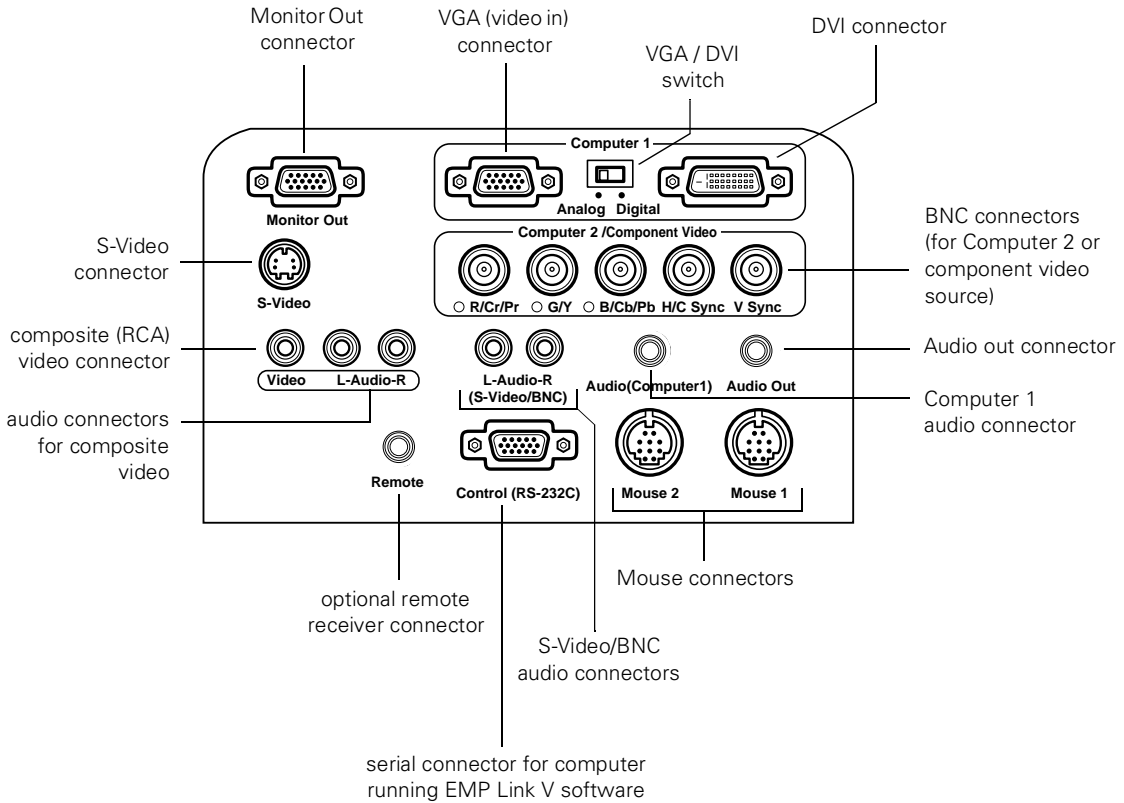

Computer Video Port Pin Assignments

The Computer 1 analog port (VGA) and the Monitor Out port are female video RGB, 15-pin micro-D-style connectors. Here are their pin assignments:

Pin no.	Computer 1 port	Monitor Out port
1	Red video	Red out / red video
2	Green video	Green out / green video
3	Blue video	Blue out / blue video
4	Monitor (ID bit 2)	Reserved
5	GND	GND
6	Red video GND	GND
7	Green video GND	GND
8	Blue video GND	GND
9	+5 V	Reserved
10	Synchronous GND	GND
11	Monitor (ID bit 0)	Reserved
12	SDA	Reserved
13	Horizontal sync	Horizontal sync
14	Vertical sync	Vertical sync
15	Reserved	Vertical sync

Image Size and Projection Distance

Use the tables below to estimate how far to place the projector from the screen. Since the size of the image can be changed by rotating the zoom ring, a range of distance is given for each screen size.

Note that if you tilt the projector upward by extending the feet or use electronic keystone correction, your image size may vary.

Standard Lens

Diagonal screen size	Distance
30 inches	3.6 - 4.3 feet (1.1 - 1.3 meters)
60 inches	7.2 - 9.2 feet (2.2 - 2.8 meters)
100 inches	12.1 - 15.7 feet (3.7 - 4.8 meters)
200 inches	24.3 - 31.8 feet (7.4 - 9.7 meters)
300 inches	36.7 - 47.6 feet (11.2 - 14.5 meters)

Long Throw Zoom Lens (ELPAL01)

Diagonal screen size	Distance
30 inches	4.46 - 5.87 feet (1.36 - 1.79 meters)
60 inches	9.35 - 12.2 feet (2.85 - 3.71 meters)
100 inches	15.8 - 20.5 feet (4.82 - 6.25 meters)
200 inches	32.1 - 41.5 feet (9.77 - 12.64 meters)
300 inches	48.3 - 62.4 feet (14.72 - 19.02 meters)

Wide Angle Lens (ELPAW01)

Diagonal screen size	Distance
30 inches	2.8 - 3.6 feet (0.85 - 1.09 meters)
60 inches	5.5 - 7.2 feet (1.69 - 2.19 meters)
100 inches	9.3 - 12.0 feet (2.82 - 3.66 meters)
200 inches	18.6 - 24.0 feet (5.67 - 7.33 meters)
300 inches	28.1 - 36.1 feet (8.57 - 11.00 meters)

Index

A

- A/V Mute button, 27, 33, 50
- A/V Mute setting, 52
- About menu, 40, 54
- Accessories, 8, 76
- Adobe Acrobat Reader, 3 to 4
- Advanced menu, 40, 53 to 54
- Air filter, cleaning and replacing, 59
- Anti-theft device, 11
- Aspect ratio, 97
- Audio
 - adjusting tone, 46 to 47
 - adjusting volume, 32, 46 to 47
 - cables, 6
 - connecting desktop, 82, 86
 - connecting laptop, 14
 - connecting second computer, 87
 - connecting video device, 16 to 18
 - menu, 40, 46 to 47
 - outputting to external sound system, 79
 - problems, troubleshooting, 73
 - turning off (using A/V Mute), 27, 33
- Audio Out jack, 79
- Auto button, 26, 44

B

- Bar tool, 37
- Bass, adjusting, 46 to 47
- Batteries, installing, 30
- BNC cables, 7
- Box tool, 36
- Brightness, 1, 97
- Brightness setting, 44

C

- Cables, 6 to 8
- Capture menu, 40
- Carrying case, 8, 63
- Ceiling mount, 8, 78

- Cleaning
 - air filter, 59
 - lens, 58
 - projector case, 58
- Comp2/BNC button, 73
- Component video cable, 7, 15
- Composite video cable, 15
- Computer cable, 6
- Computer connector pin assignments, 103
- Computer settings, saving, 45 to 46
- Computers supported, 1
- Connecting projector
 - to a BNC computer source, 87
 - to a desktop Macintosh, 83 to 86
 - to a desktop PC, 80 to 82
 - to a DVI computer source, 89
 - to a high-end workstation, 88
 - to a laptop, 12 to 14
 - to a second computer, 87
 - to a video source, 15 to 18
- Connector pin assignments, 103
- Contrast setting, 44

D

- Declaration of Conformity, 94
- Default settings, restoring, 42, 55
- Desktop adapter, Macintosh, 83 to 84
- Desktop computer, connecting projector to,
 - 80 to 82, 83 to 86
- Digital visual interface
 - See DVI
- Distance from projector to screen, 10,
 - 104 to 105
- Drawing on the screen, 35 to 37
- DVI (Digital Visual Interface)
 - cable, 7, 8
 - source, connecting to, 89

E

- Effect menu, 40, 47 to 48

Electrical specifications, 98
EMP Link V, 3, 78 to 79
Enter button, 31
Environmental specifications, 99
EPSON
 accessories, 8, 76
 PrivateLine Support, 5, 75
 technical support, 5, 75 to 76
Esc button, 38
E-Zoom button, 33

F

FCC compliance statement, 95
Filter
 See Air filter
Focusing, 24
Foot release levers, 25
Freeze button, 33
FTP site, EPSON, 75

G

Gamma setting, 44

H

Height of image, adjusting, 25
Help, 4 to 5, 75 to 76
Help button, 66
Help system, using, 66
Highlighting tools, 35 to 37

I

iBook, connecting to, 12
iMac, connecting to, 7
Image
 adjusting, 24 to 26, 43 to 45
 capturing and saving in projector, 49
 correcting shape of, 26, 52, 72
 focusing, 24
 height, adjusting, 25
 positioning, 25, 44
 problems with, troubleshooting, 69 to 73
 raising, 25
 resizing, 25

Image (continued):
 shape, correcting, 26, 52, 72
 size and projection distance, 10, 104 to 105
 size range, 97
 turning off (using A/V Mute), 27, 33
 zooming, 24, 33
Installing projector, 78 to 79

K

Kensington anti-theft device, 11
Keystone button, 26
Keystone correction, 26, 72, 97

L

Lamp
 number of hours used, 54
 replacing, 60 to 62
 specifications, 98
 status light, 67
 timer, resetting, 62
Language setting, 66
Laptop computer
 connecting to, 12 to 14
 displaying on, 23, 70
Lens
 cleaning, 58
 long throw zoom, 8, 104
 specifications, 97
 standard, 104
 wide angle, 8, 105
Light button (on remote control), 30
Lights, status, 67 to 69
Lines, drawing on screen, 37
Logo, saving on projector, 49 to 51
Long throw zoom lens, 8, 104

M

Macintosh
 connecting projector to, 83 to 86
 desktop adapter, 83 to 84
 monitor adapter, 83 to 84
Manuals, 3 to 5

Menus

- About, 40, 54
- Advanced, 40, 53 to 54
- Audio, 40, 46 to 47
- Capture, 40
- changing settings, 40 to 42
- Effect, 40, 47 to 48
- Reset All, 40, 55
- Setting, 40, 51 to 52
- using, 40 to 42
- Video, 40, 43 to 45

Monitor adapter, Macintosh, 83 to 84

Monitor Out pin assignments, 103

N

No-Signal Msg setting, 52

O

Options for projector, 8

P

P in P (picture in picture) button, 34

Picture

See Image

Picture-in-picture video source, selecting, 52

Pin assignments, connector, 103

Pointer tool, 35

Positioning image, 25

Positioning the projector, 10 to 11, 104 to 105

Power

- button, 21
- consumption, 98
- status light, 67
- supply, 98

Presenters Online, 4, 75

Preset

- button, 46
- option, 45 to 46

PrivateLine Support, 5, 75

Projection lamp

See Lamp

Projector

- carrying case, 8, 63
- cleaning, 58
- controlling from computer, 3, 78 to 79
- distance from screen, 10, 97, 104 to 105
- feet, adjusting height with, 25
- installing, 78 to 79
- lamp specifications, 98
- options, 8
- positioning, 10 to 11, 104 to 105
- resolution, 1, 97
- shutting off, 28
- software, 5
- transporting, 63
- troubleshooting, 65 to 73
- turning off, 28
- turning on, 20
- unpacking, 6 to 7
- viewing information about, 54

Prompt setting, 52

PS/2 mouse cable, 6

R

Raising image, 25

Rear-screen projection, 78

Registration, 5

Remote control

- light button, 30
- numbered buttons, 35
- problems, 74
- specifications, 98
- troubleshooting, 93
- turning on, 30
- using, 29 to 38
- using as wireless mouse, 38

Replacing lamp, 60 to 62

Reset All menu, 40, 55

Resetting lamp timer, 62

Resetting menu options, 42, 55

Resize button, 25

Resizing image, 25

Resolution, 1, 97

S

- Safety instructions, 91 to 92
- Screen image
 - See* Image
- Screen, distance from projector, 10, 104 to 105
- Setting menu, 40, 51 to 52
- Sharpness setting, 44
- Sleep mode, 28
- Software, 5
- Sound
 - adjusting tone, 46 to 47
 - adjusting volume, 32, 46 to 47
 - problems, troubleshooting, 73
 - turning off (using A/V Mute), 27, 33
 - See also* Audio
- Source, selecting, 27, 32
- Speakers, specifications, 97
- Special effects buttons, 35 to 37
- Specifications
 - brightness, 1, 97
 - electrical, 98
 - environmental, 99
 - general, 97
 - lamp, 98
 - lens, 97
 - remote control, 98
 - resolution, 1, 97
 - safety, 99
- Spotlight tool, 36
- Startup screen, creating, 49 to 51
- Status lights, 67 to 69
- Stopping action, 33
- Support
 - See* Technical support
- S-Video cable, 7, 15
- Synchronization, adjusting, 26

T

- Technical support, 5, 75 to 76
- Temperature
 - requirements, 99
 - status light, 67

- Tone setting, 46 to 47
- Tracking, adjusting, 26
- Transporting projector, 63
- Treble, adjusting, 46 to 47
- Troubleshooting
 - image and sound problems, 69 to 73
 - projector problems, 65 to 73
 - remote control problems, 74
- Turning off picture (using A/V Mute), 27, 33
- Turning off projector, 28
- Turning on projector, 20

U

- Unpacking projector, 6 to 7
- USB mouse cable, 6

V

- Video
 - button, 32
 - display settings, viewing, 54
 - formats, supported, 1, 99 to 101
 - menu, 40, 43 to 45
 - picture in picture, 52
 - port pin assignments, 103
 - selecting source, 27, 32
- Video cables, 6
- Video sources, connecting projector to, 15 to 18
- Volume
 - adjusting, 32
 - button, 32
 - setting, 46 to 47

W

- Warning lights, 67 to 69
- Warranty, 5
- Wide angle lens, 8, 105
- Workstations, connecting projector to, 88

Z

- Zoom ratio, 97
- Zooming image, 24, 33